

# TIMING DETERMINISTIC STRUCTURAL MODEL UPDATING CONSIDERING IMPACT AND FATIGUE DAMAGE

**Jason Smith**<sup>1</sup>, **Austin Downey**<sup>1,2</sup>, **Alysson Mondoro**<sup>3</sup>, **Benjamin Grisso**<sup>3</sup>

<sup>1</sup> Department of Mechanical Engineering, University of South Carolina, Columbia, SC, USA

<sup>2</sup> Department of Civil Engineering, University of South Carolina, Columbia, SC, USA

<sup>3</sup> Naval Surface Warfare Center – Carderock Division, West Bethesda MD, USA



# OVERVIEW

- Importance and significance
- Methodology
- Results
- Next steps



[Mass Communication Specialist 1st Class James R. Evans, Public domain, via Wikimedia Commons]

# Importance and significance

# WHAT IS A DIGITAL TWIN?

- A Digital Twin continuously forecasts the health of the vehicle or system, the remaining useful life and the probability of mission success.
- The Digital Twin can also predict system response to safety critical events and uncover previously unknown issues before they become critical by comparing predicted and actual responses.



[SumitAwinash, CC BY-SA 4.0 <<https://creativecommons.org/licenses/by-sa/4.0/>>, via Wikimedia Commons]



# DIGITAL TWIN VS MODEL

## Model

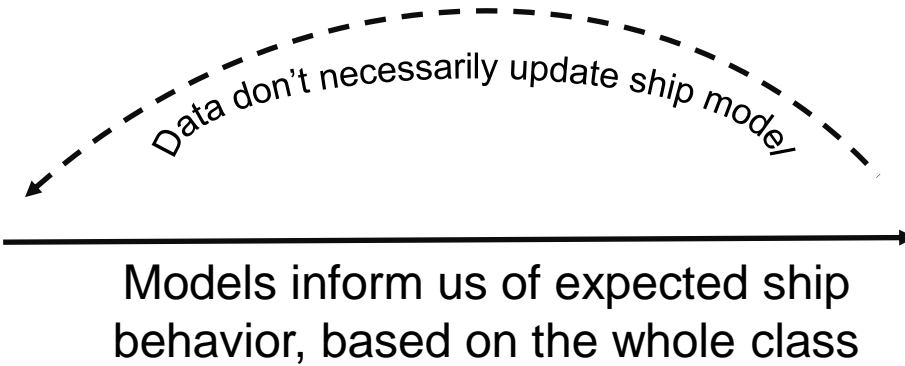
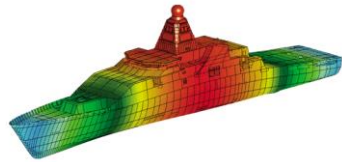

## Digital Twin

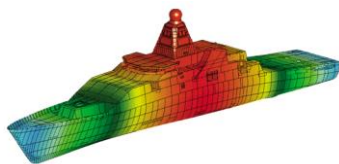

Class-wide models serve as a starting point

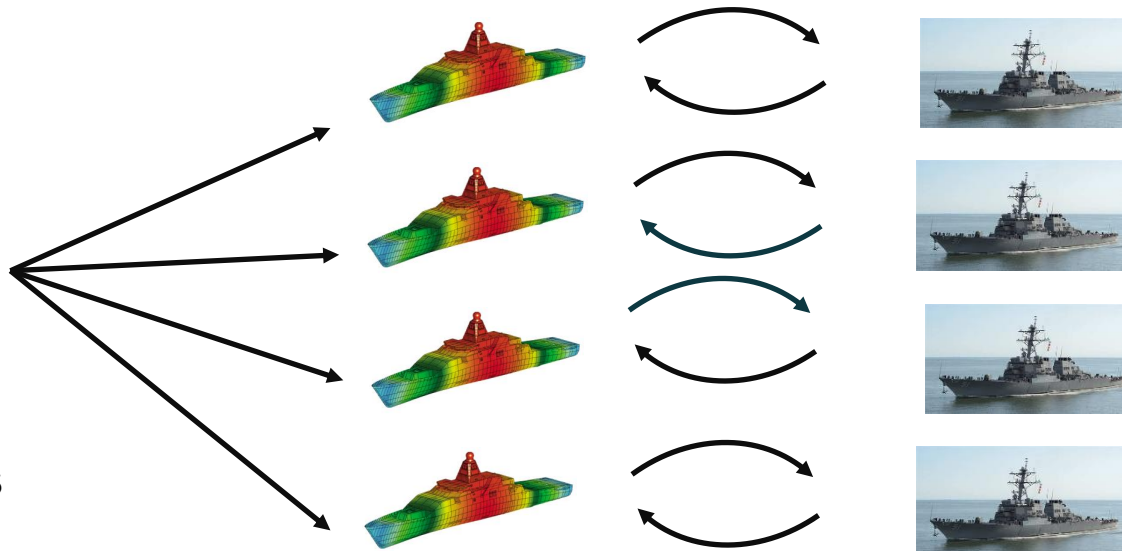

Twin is updated with data from the ships

Twins track condition of each individual hull



South Carolina

# DIGITAL TWIN ENABLING TECHNOLOGIES AND GAPS

## Enabling Technologies

- Machine Learning
- Distributed Analytics
- Cloud-based Computing
- High-bandwidth Secure Communications

## Engineering Gaps

- Integration of ship- and off-board sensor systems that store data
- Multi-level classification communications
- Integrating cloud-based computing
- Distributed (GPU-based) computing high-fidelity
- Cybersecurity
- Workforce expertise with data analytic skill set and tools

## Technology Gaps

- “Automatic” fusing of data with models
- Applied machine learning
- Application to sparse data
- Integration of complex environmental data
- Use of data at order-of-magnitude different temporal/spatial scales
- Algorithmic approaches for measured data
- Virtual sensing (sensor inference)
- Extending prognostications
- Uncertainty analysis and propagation
- Cybersecurity
- Optimized control of systems

# Methodology

# ONLINE MODEL UPDATING FRAMEWORK

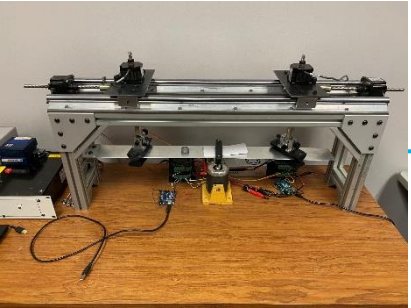

Structure

Data

$$F_{trun} = \sum_{i=1}^n \left(\frac{d_i}{\omega_i}\right)^2 \bar{\phi}_i \bar{\phi}_i^T$$

$$\Delta F_{trun} = F_{trun}^{true} - F_{trun}^{trial}$$

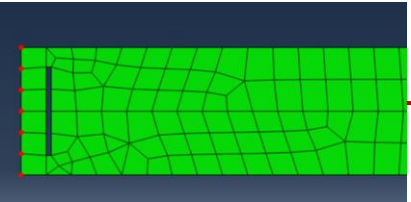

FEA model

Data

$$F_{trun} = \sum_{i=1}^n \left(\frac{d_i}{\omega_i}\right)^2 \bar{\phi}_i \bar{\phi}_i^T$$

Inverse feature scaling

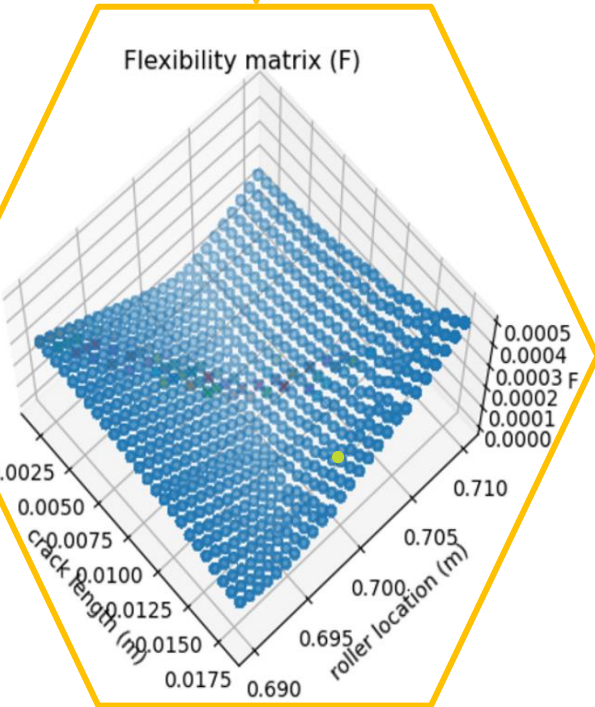
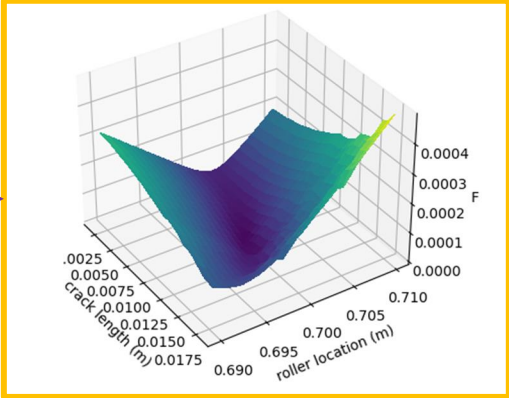



# FLEXIBILITY MATRIX

$$\bar{\phi}_i = \phi_i d_i$$

$\bar{\phi}_i$  : normalized mode shape

$d_i$  :  $i^{\text{th}}$  mode mass normalization constant

$$F_{trun} = \sum_{i=1}^n \left( \frac{d_i}{\omega_i} \right)^2 \bar{\phi}_i \bar{\phi}_i^T$$

$F_{trun}$  : truncated flexibility matrix

$\omega_i$  : modal frequencies matrix

$$\Delta F_{trun} = F_{trun}^{true} - F_{trun}^{trial}$$

$F_{trun}^{true}$  : true (damaged) structure flexibility matrix

$F_{trun}^{trial}$  : trial (FE model) structure flexibility matrix

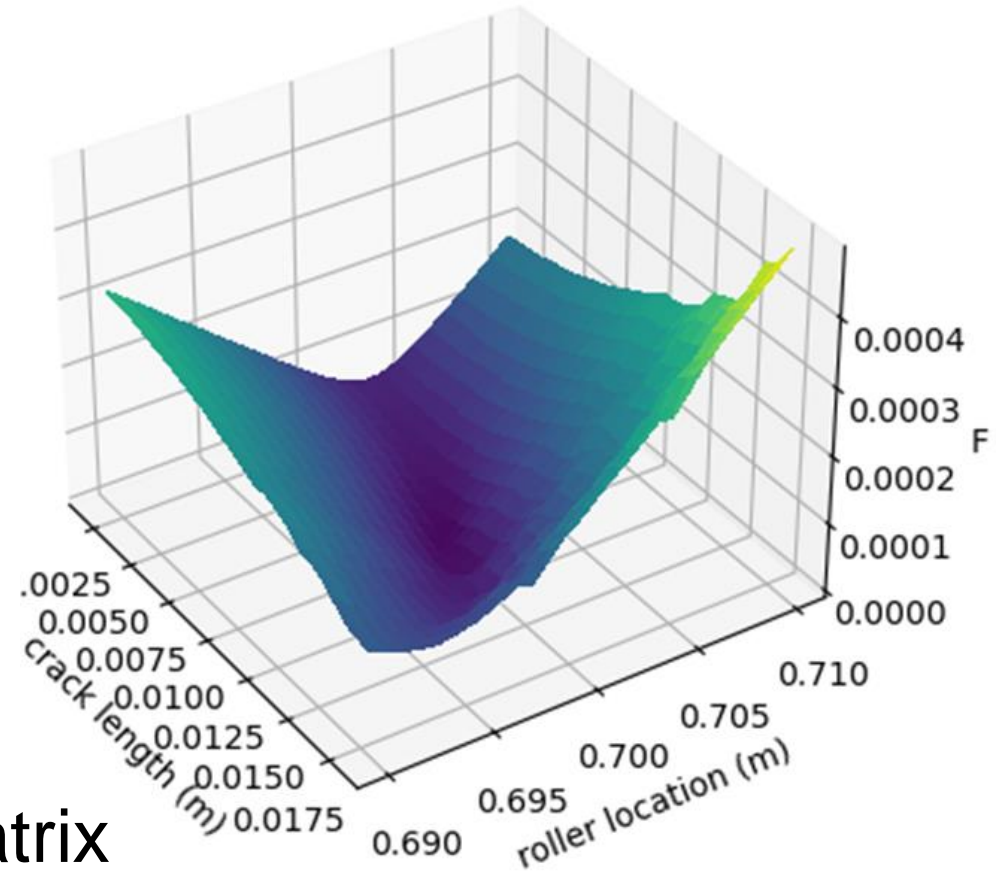

# PARTICLE SWARMS

Velocity update:

- $V_{(t+1)}^i = wV_{(t)}^i + c_1u_1(p_{best}^i - X_{(t)}^i) + c_2u_2(g_{best} - X_{(t)}^i)$ 
  - $w$  = inertia weight constant (0 - 1)
  - $c_1, c_2$  = cognitive and social coefficients
  - $p_{best}, g_{best}$  = best position so far

Position update:

- $X_{(t+1)}^i = X_{(t)}^i + V_{(t+1)}^i$ 
  - $X_{(t)}^i$  = current position
  - $V_{(t+1)}^i$  = updated velocity

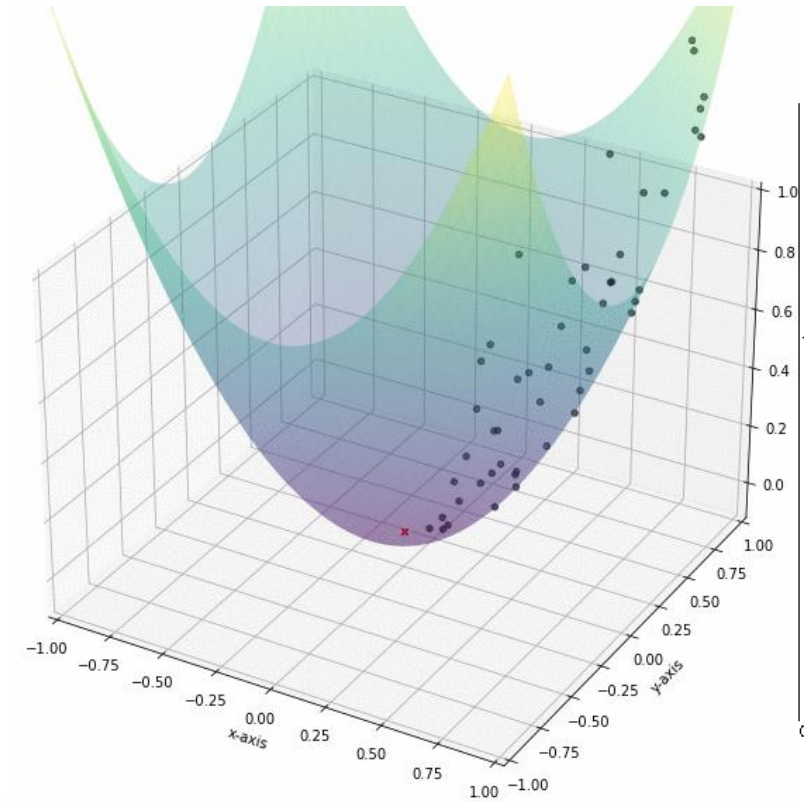
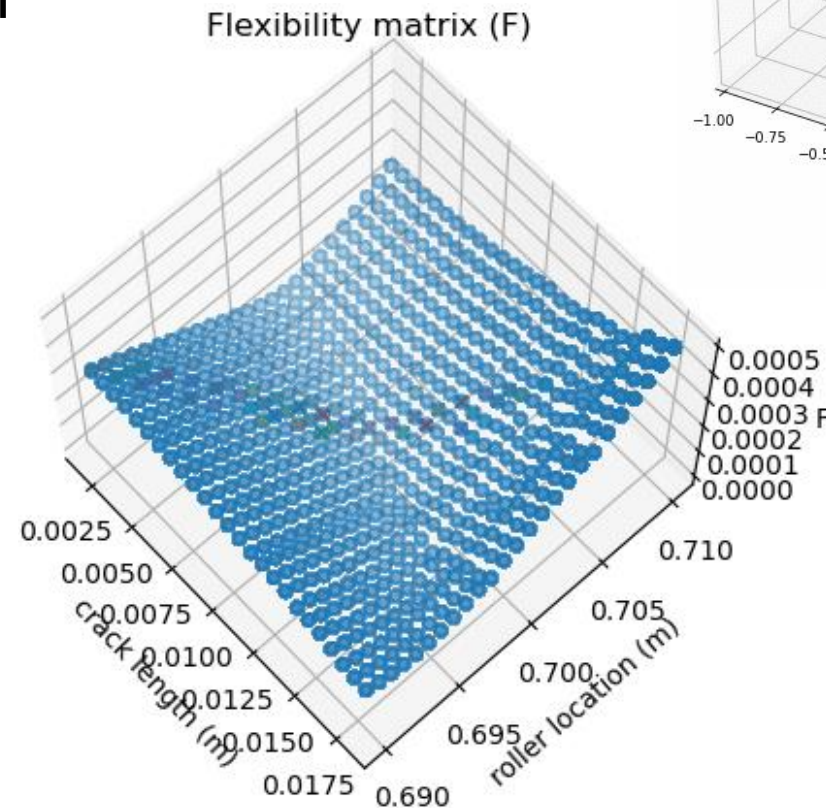

# Testbed

# SHIP STRUCTURE AND FATIGUE ENVIRONMENT (SHIP SAFE) TESTBED

- Designed to allow for changes to the structure's stiffness using the stepper motors.
- Structure's stiffness changes are reversible.
- Produces simple data sets used for validating multi-model data assimilation algorithms.

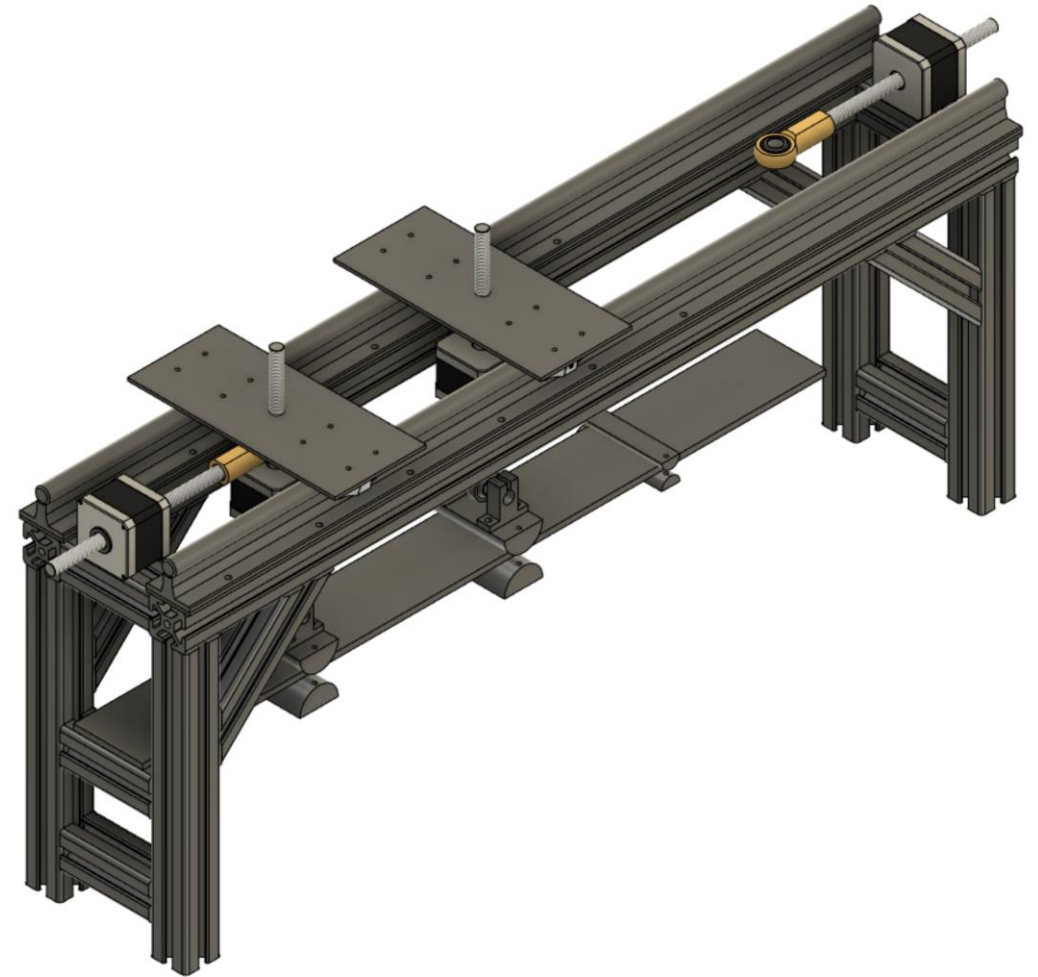

CAD model of ship safe testbed



# SHIP STRUCTURE AND FATIGUE ENVIRONMENT (SHIP SAFE) TESTBED

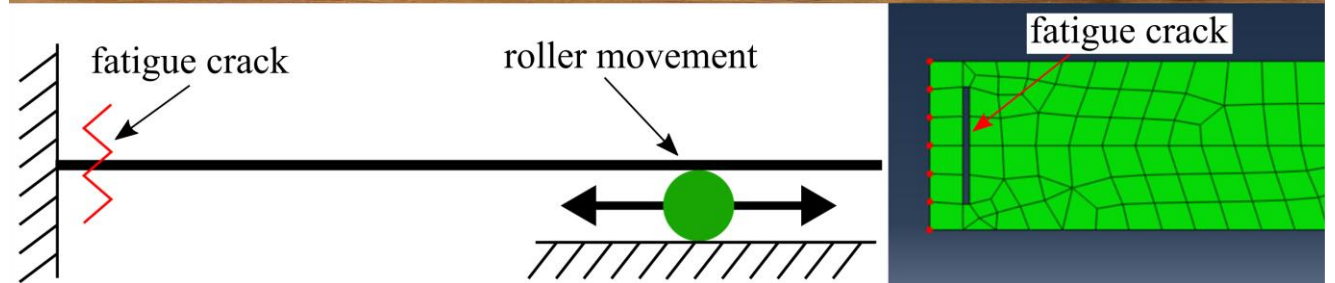
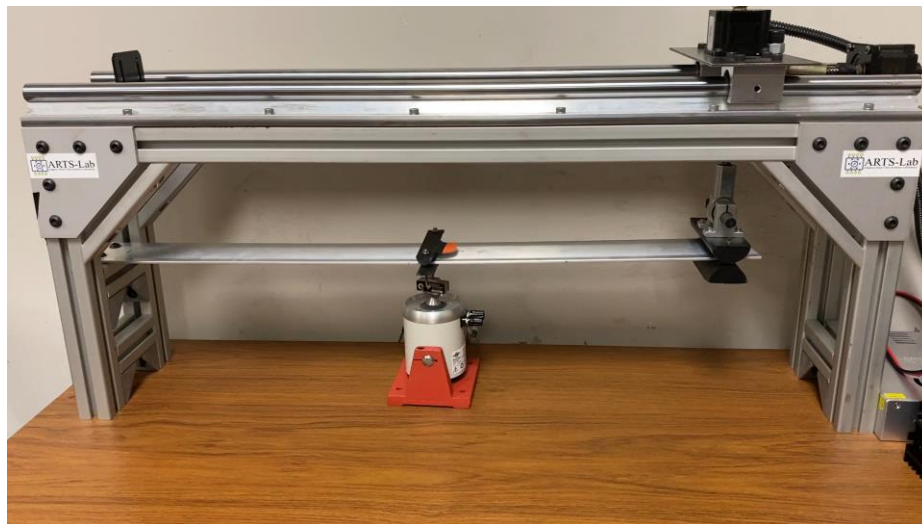
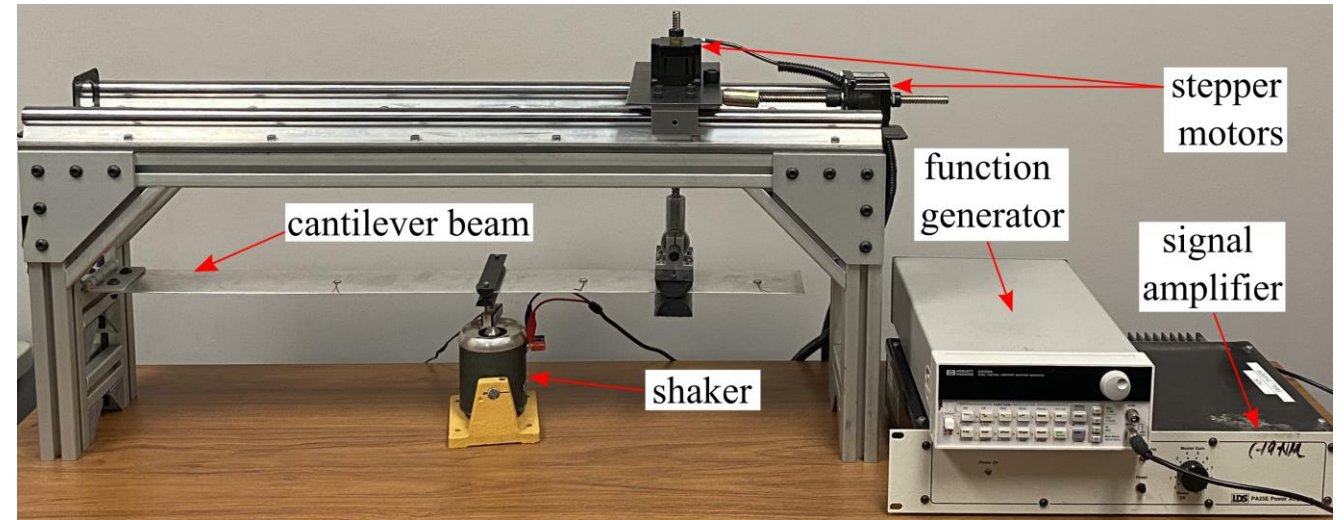



# INSERTING A LINEAR CRACK



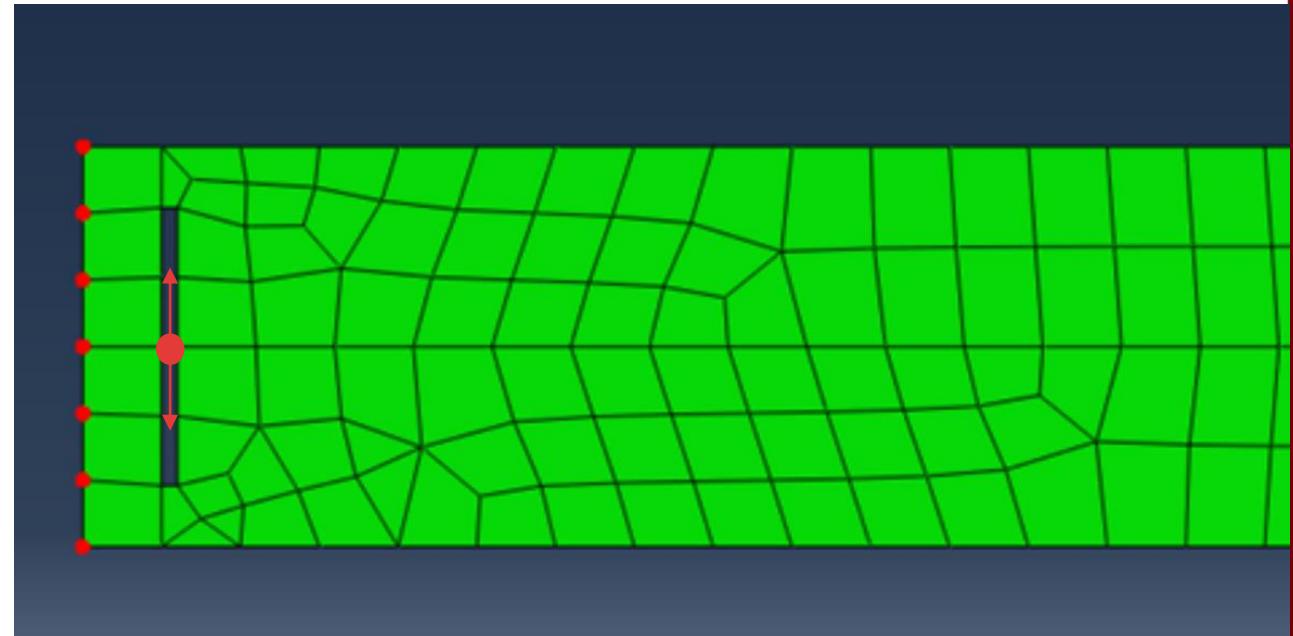

- Damage cases:
  - Fatigue crack length
  - Roller location along the beam
- Crack starts near the beams left fixity and grows from the beam center outward toward each edge.

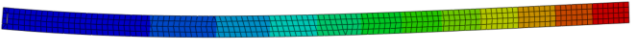

# FINITE ELEMENT ANALYSIS MODEL

Modeled in Abaqus:

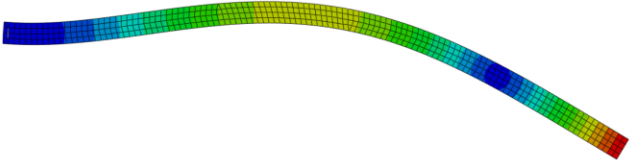
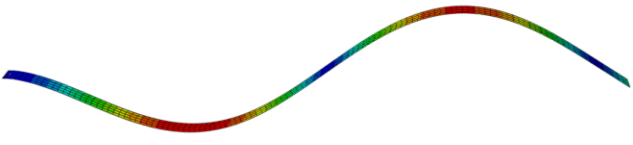
- Initially built as 3-D model.
  - Most accurate to physical model.
- Finalized as a 2-D model
  - BCs and input forces act in 2-D.
  - Computationally efficient.
  - Produces identical data.

Mode	Frequency	Mode Type	Shape
1	36.036 Hz	Bending - Y	
2	69.790 Hz	Bending - Z	
3	224.81 Hz	Bending - Y	
4	225.92 Hz	Bending - Z	
5	470.05 Hz	Bending - Z	

# MODAL ASSIMILATION

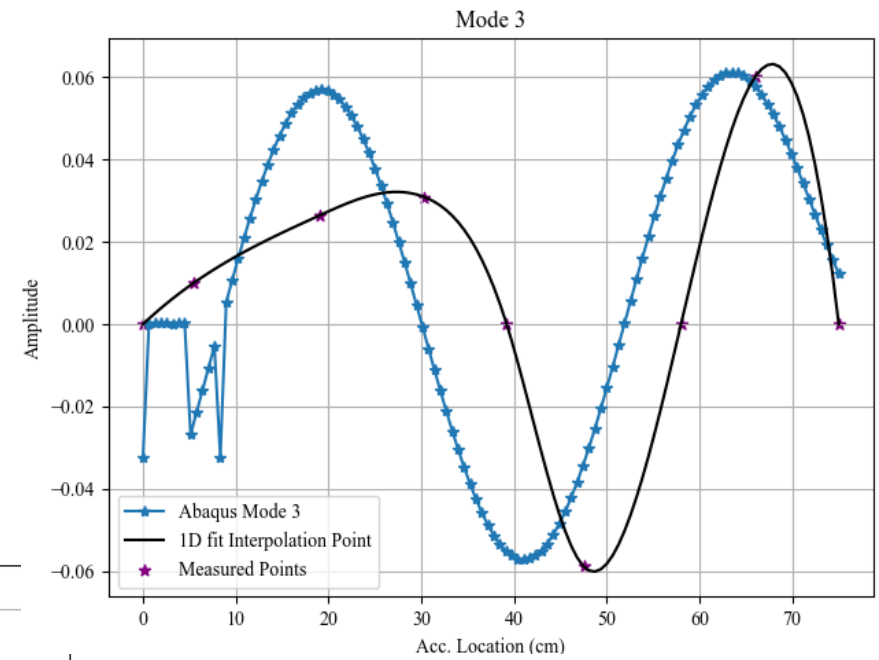
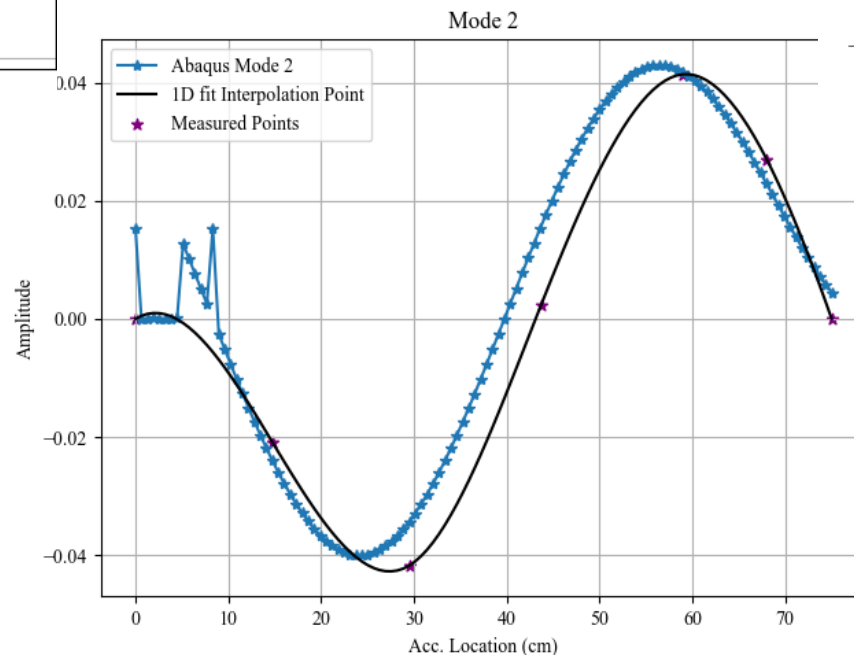
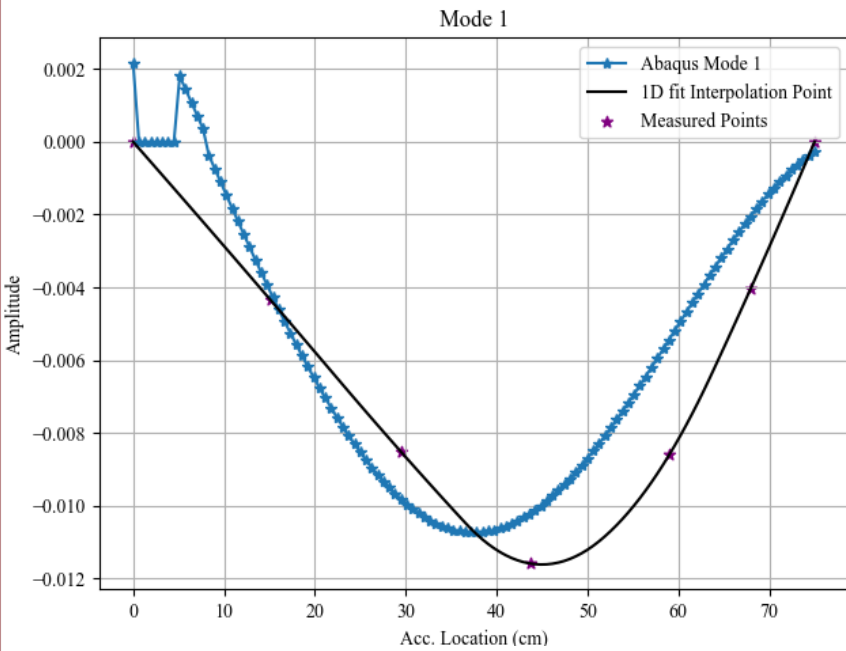

# MAC AND ORTHOGONALITY METRICS

Modal Assurance Criterion

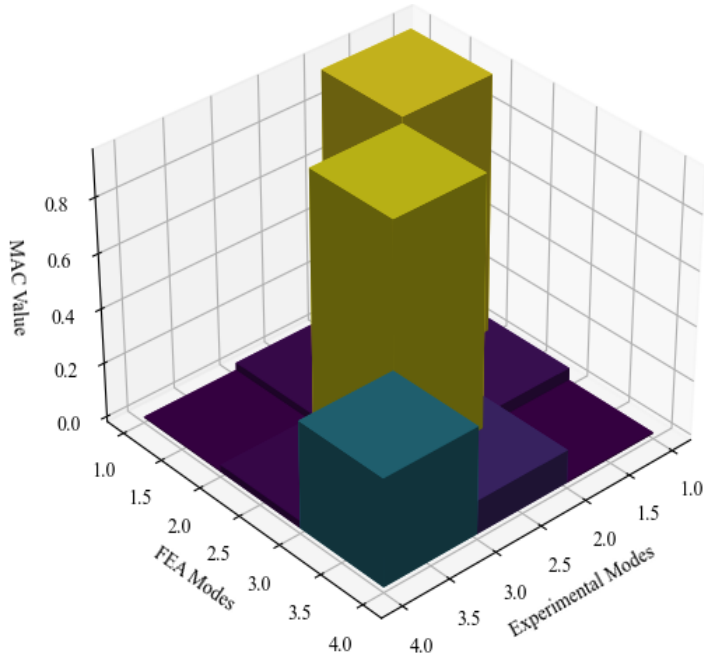

$$MAC_{ij} = \frac{[\{a_i\}^T \{b_j\}]^2}{[\{a_i\}^T \{a_i\}][\{b_j\}^T \{b_j\}]}$$

Mode shape statistical indicator which is most sensitive to large differences and relatively insensitive to small differences. Provides a good statistic indicator and a degree of consistency between mode shapes.

Orthogonal modes cannot construct any one mode with any linear combination of the others. Moreover, you can't even construct part of one mode through any linear combination of the others.

Orthogonality

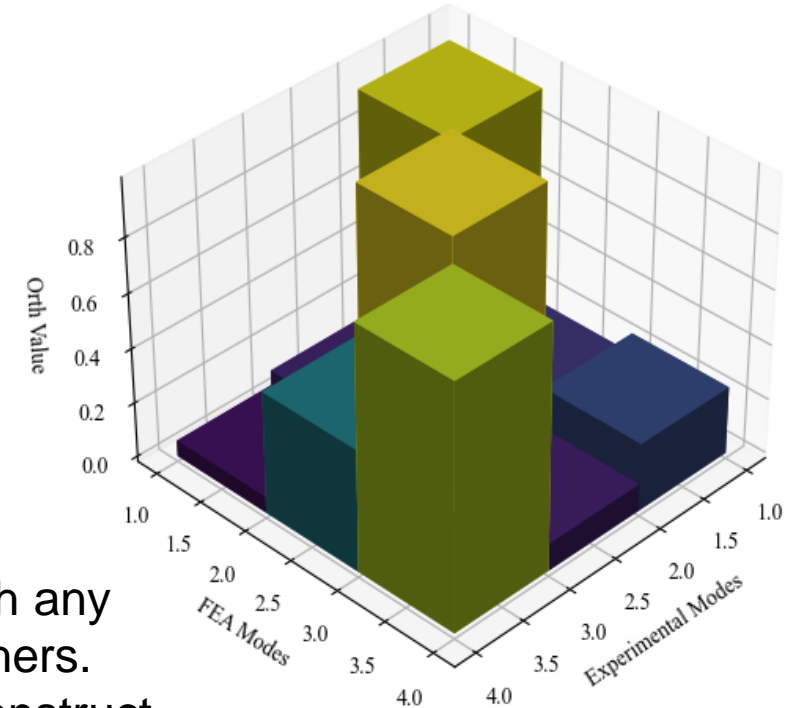

$$ORT_{ij} = \{u_i\}^T [M] \{j_j\}^T$$

# Results (Simulation Only)



# CONDITION TRACKING

- Build a “Smart Beam”
  - Connection inside ship structure.
  - Tracks foreground and background changes.
  - Damage to supports and fatigue cracks.

Smart Beam condition tracking

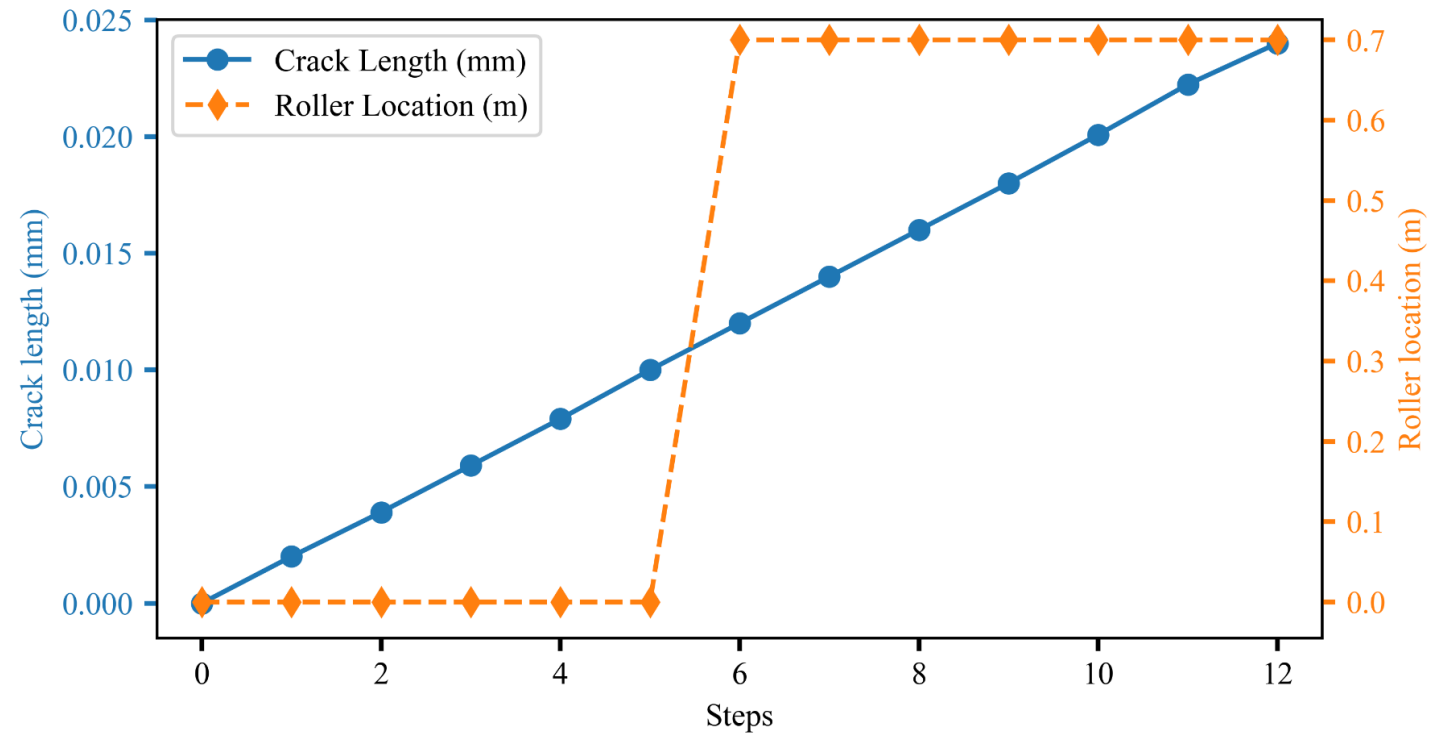

# PARTICLE SWARM

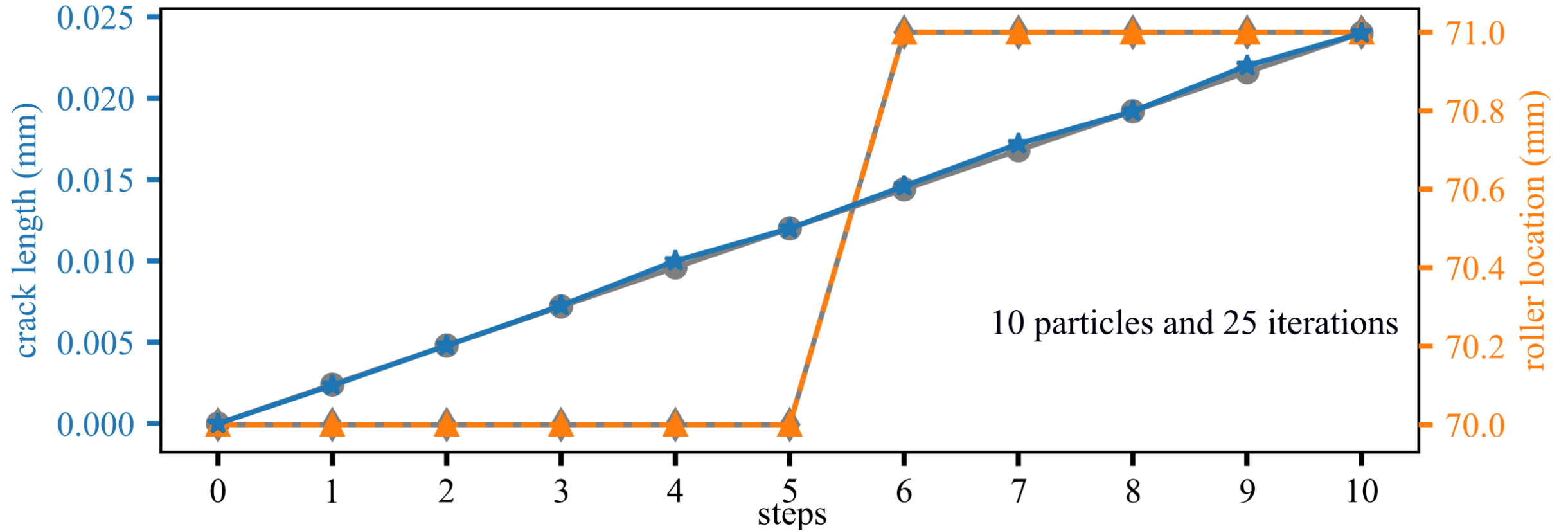

# Next steps

# NEXT STEPS

1. Experimental validation
2. Demonstration for a system under continuous loading
3. Online real-time model updating demonstration



# ACKNOWLEDGEMENTS



This material is based upon work partly supported by the Air Force Office of Scientific Research (AFOSR) through award no. FA9550-21-1-0083. This work is also partly supported by the National Science Foundation Grant number 1850012. The support of these agencies is gratefully acknowledged. Any opinions, findings, and conclusions, or recommendations expressed in this material are those of the authors and do not necessarily reflect the views of the National Science Foundation or the United States Air Force.



# REFERENCES

1. Avitabile, Peter. "Modal Space - University of Massachusetts Lowell." *Modal Space Articles*, Society for Experimental Mechanics and Blackwell Publishing, 2014, [https://www.uml.edu/docs/Aug14\\_tcm18-189916.pdf](https://www.uml.edu/docs/Aug14_tcm18-189916.pdf).
2. Avitabile, Peter. *Modal Testing: A Practitioner's Guide*. John Wiley & Sons, 2018.
3. Drazen, D., Mondoro, A., and Grisso, B., "Use of digital twins to enhance operational awareness and guidance," in [Proc. Conf. Comput. IT Appl. Marit. Ind], 18, 344–351 (2019).
4. Kurata, M, Kim, J, Lynch, JP, Law, KH, & Salvino, LW. "A Probabilistic Model Updating Algorithm for Fatigue Damage Detection in Aluminum Hull Structures." *Proceedings of the ASME 2010 Conference on Smart Materials, Adaptive Structures and Intelligent Systems. ASME 2010 Conference on Smart Materials, Adaptive Structures and Intelligent Systems, Volume 2*. Philadelphia, Pennsylvania, USA. September 28–October 1, 2010. pp. 741-750. ASME.
5. Mondoro, A. and Grisso, B., "On the integration of SHM and digital twin for the fatigue assessment of naval surface ships," in [Structural Health Monitoring 2019], DEStech Publications, Inc. (nov 2019).

# QUESTIONS?

Jason Smith

Mechanical Engineering, M.S.M.E May 2023

SMART Scholar

Jms32@email.sc.edu

# WHAT IS DIGITAL TWIN?



*Cyber-physical systems are engineered systems that are built from, and depend upon, the seamless integration of computation and physical components*



**A Digital Twin is an integrated Multiphysics, multiscale, probabilistic simulation of an as-built vehicle or system that uses the best available physical models, sensor updates, fleet history, etc., to mirror the life of its corresponding flying twin.** The Digital Twin is ultra-realistic and may consider one or more important and interdependent vehicle systems, including airframe, propulsion and energy storage, life support, avionics, thermal protection, etc. The extreme requirements of the Digital Twin motivate the integration of design of materials and revolutionary approaches for material processing. Manufacturing anomalies that may affect the vehicle are also explicitly considered, evaluated and monitored. In addition to the backbone of high-fidelity physical models of the as-built structure, the Digital Twin integrates sensor data from the vehicle's on-board integrated vehicle health management (IVHM) system, maintenance history and all available historical and fleet data obtained using data mining and text mining.



By combining all this information, **the Digital Twin continuously forecasts the health of the vehicle or system, the remaining useful life and the probability of mission success.** The Digital Twin can also predict system response to safety critical events and uncover previously unknown issues before they become critical by comparing predicted and actual responses. Finally, the systems on board the Digital Twin are capable of mitigating damage or degradation by activating self-healing mechanisms or by recommending changes in mission profile to decrease loadings thereby increasing both the life span and the probability of mission success.



*Navy Digital Twin is a continuous analytical fusion of data, physics-based models, and machine learning to prescribe **multiple future instantiations** of the ship and its environment, which enables the user to readily identify the optimum choices*

# DETERMINING BEST PS PARAMETERS

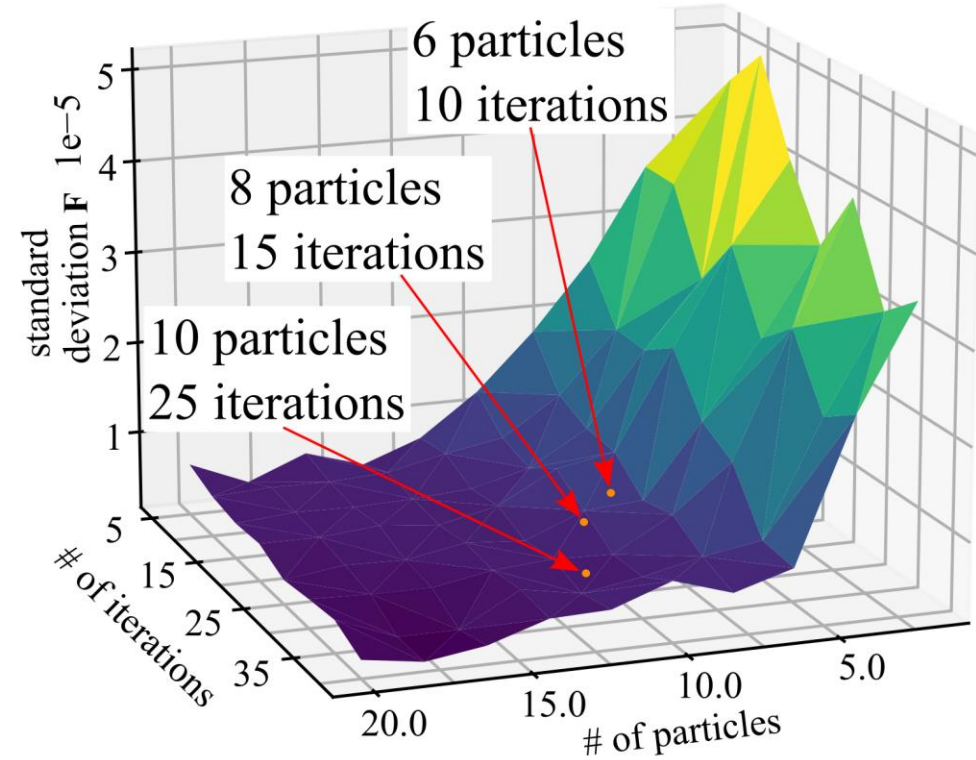
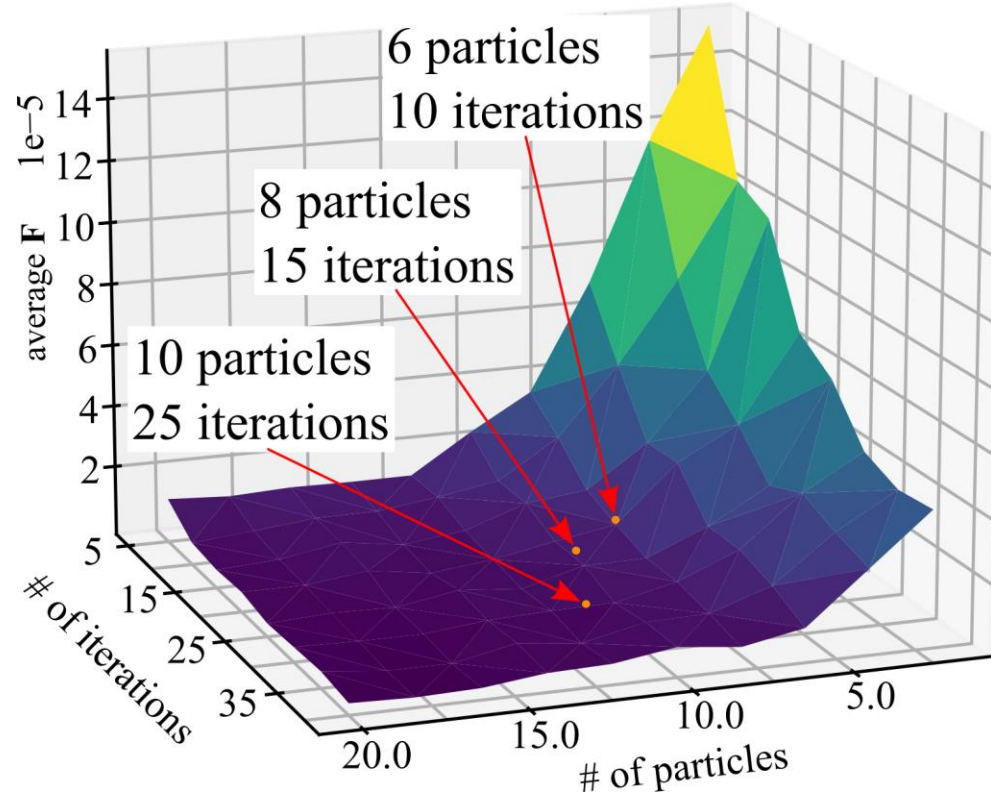

# PROJECT FLOWCHART

- Update an FEA model of the “Smart Beam” in real-time.

Physical Model (PM)

