



UNIVERSITY OF  
**SOUTH CAROLINA**

# CSCE 574 ROBOTICS

## Mapping



# Introduction to Mapping

---

- What the world looks like?
- Knowledge representation
  - Robotics, AI, Vision
- Who is the end-user?
  - Human or Machine
- Ease of Path Planning
- **Uncertainty!**



# Simultaneous Localization And Mapping

---

**SLAM** is the process of building a map of an environment while, at the same time, using that map to maintain the location of the robot.

- Problems for SLAM in large scale environments:
  - Controlling growth of uncertainty and complexity
  - Achieving autonomous exploration



# Consider this Environment:

---

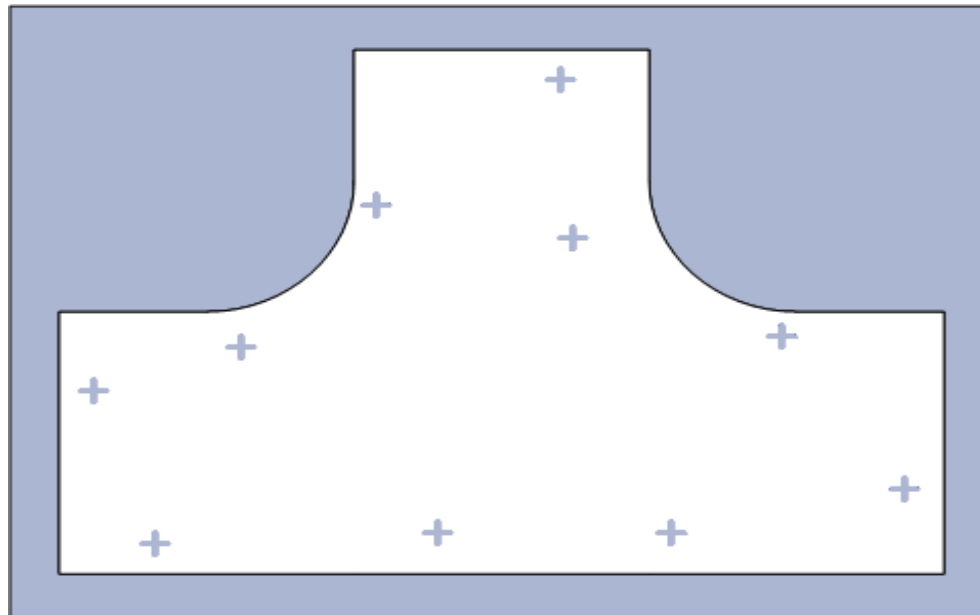

# Three Basic Map Types

## Grid-Based:

Collection of discretized obstacle/free-space pixels

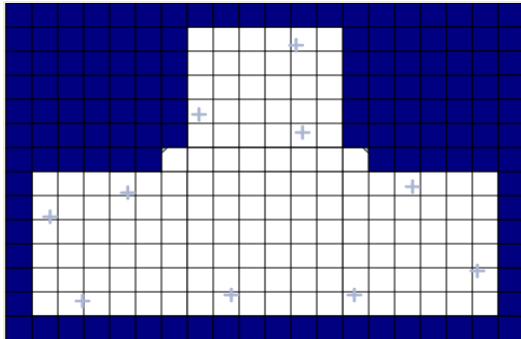

## Feature-Based:

Collection of landmark locations and correlated uncertainty

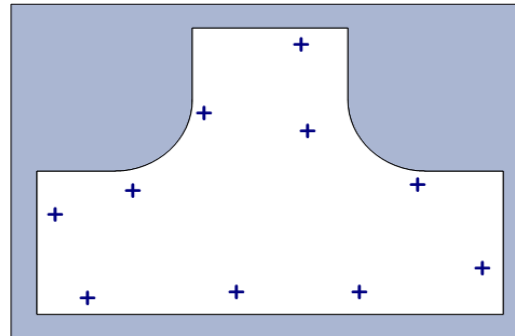

## Topological:

Collection of nodes and their interconnections

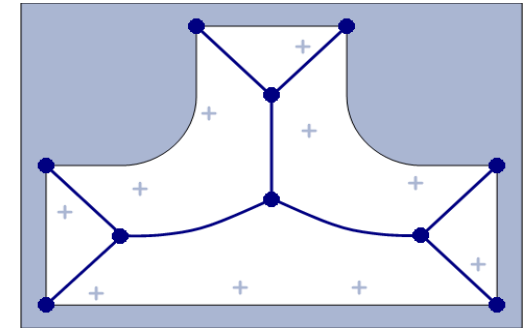

# Three Basic Map Types

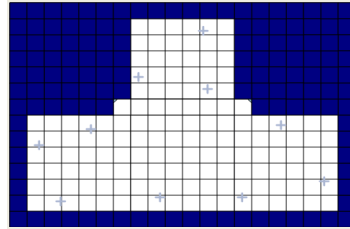

Grid-Based

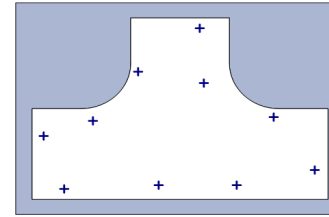

Feature-Based

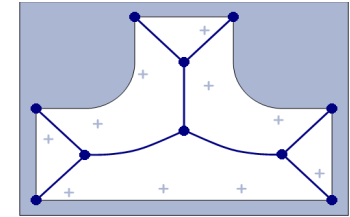

Topological

	Grid-Based	Feature-Based	Topological
Construction	Occupancy grids	Kalman Filter	Navigation control laws
Complexity	Grid size <i>and</i> resolution	Landmark covariance ( $N^3$ )	Minimal complexity
Obstacles	Discretized obstacles	Only structured obstacles	GVG defined by the safest path
Localization	Discrete localization	Arbitrary localization	Localize to nodes
Exploration	Frontier-based exploration	No inherent exploration	Graph exploration

# Other Maps

---

	Appearance Based	Geometry Based	Mesh Based
Construction	Images	Lines, planes, etc	Mesh
Path Planning	N/A	Geometry based	Graph based
Localization	Arbitrary localization	Arbitrary localization	Arbitrary localization



# Mapping

---

World

Robot

Map





# Mapping

---

World

- Indoor/Outdoor
- 2D/2.5D/3D
- Static/Dynamic
- Known/Unknown
- Abstract (web)

Robot

Map



# Mapping

---

World

Robot

- Mobile
  - Indoor/Outdoor
  - Walking/Flying/Swimming
- Manipulator
- Humanoid
- Abstract

Map



# Mapping

---

World

Robot

Map

- Topological
- Metric
- Feature Based
- 1D, 2D, 2.5D, 3D



# Mapping

---

## World

- Indoor/Outdoor
- 2D/2.5D/3D
- Static/Dynamic
- Known/Unknown
- Abstract (web)

## Robot

- Mobile
  - Indoor/Outdoor
  - Walking/Flying/Swimming
- Manipulator
- Humanoid
- Abstract

## Map

- Topological
- Metric
- Feature Based
- 1D,2D,2.5D,3D



# Sonar sensing

“The sponge”

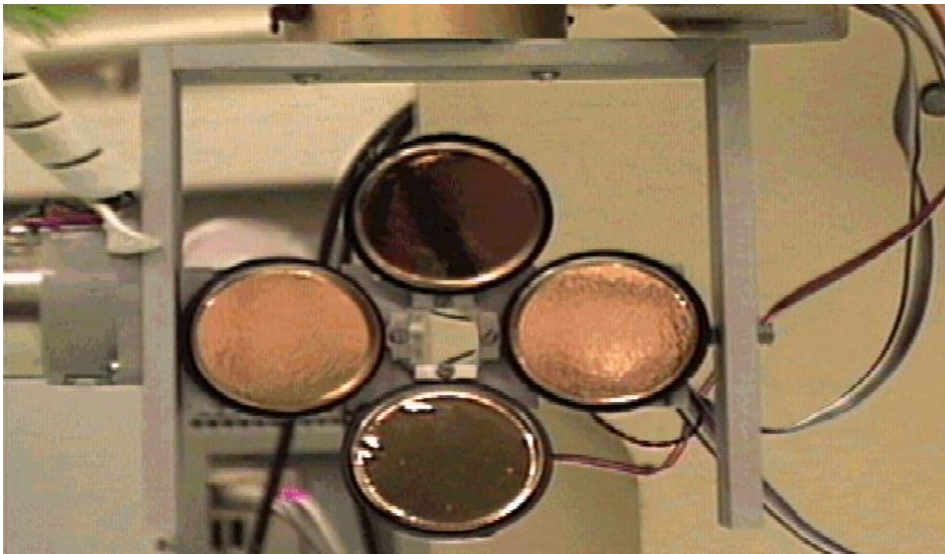
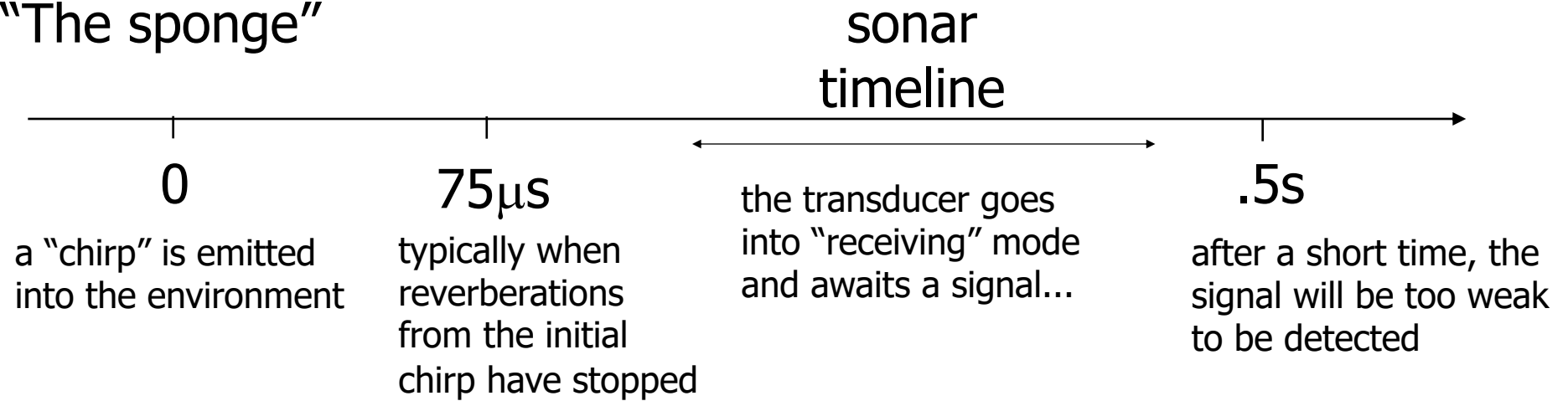

Polaroid sonar emitter/receivers

# Sonar effects

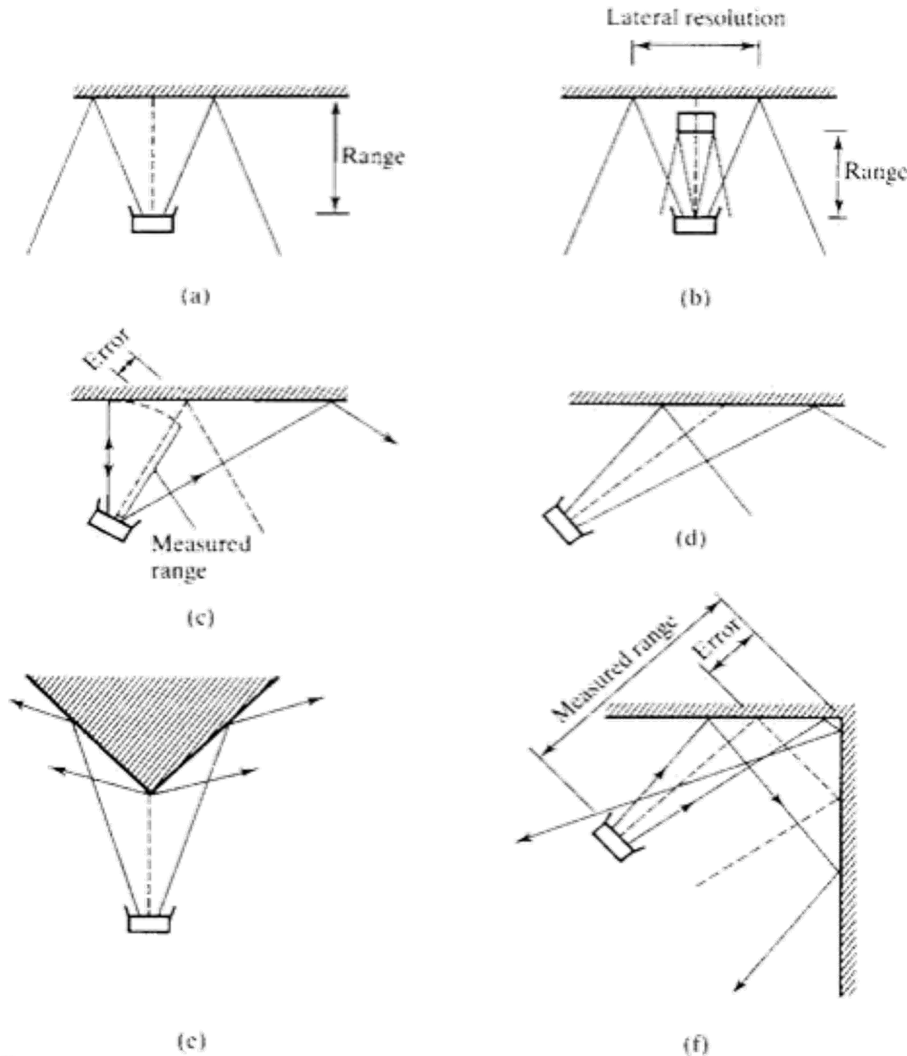

(a) Sonar providing an accurate range measurement

(b-c) Lateral resolution is not very precise; the closest object in the beam's cone provides the response

(d) Specular reflections cause walls to disappear

(e) Open corners produce a weak spherical wavefront

(f) Closed corners measure to the corner itself because of multiple reflections --> sonar ray tracing

resolution: time / space

# Sonar modeling

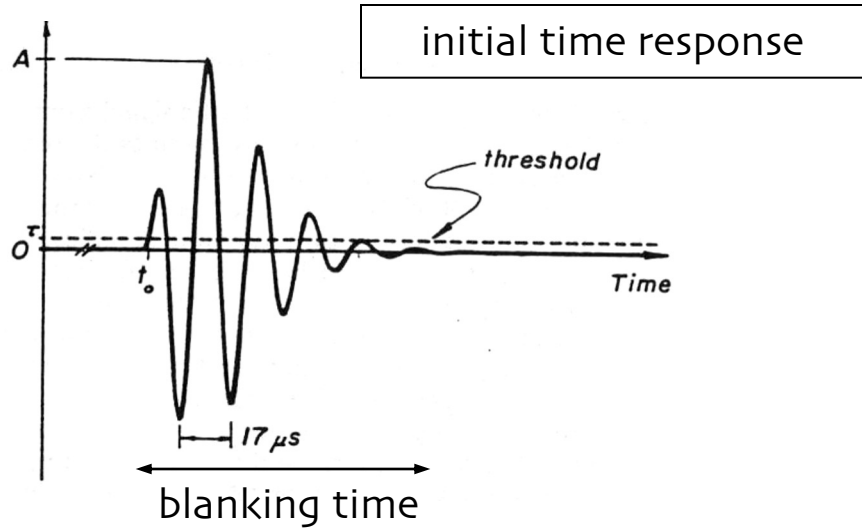

accumulated responses

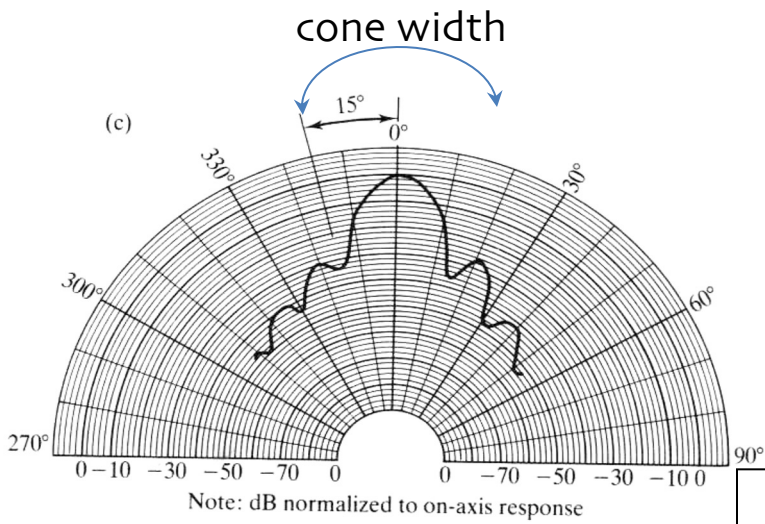
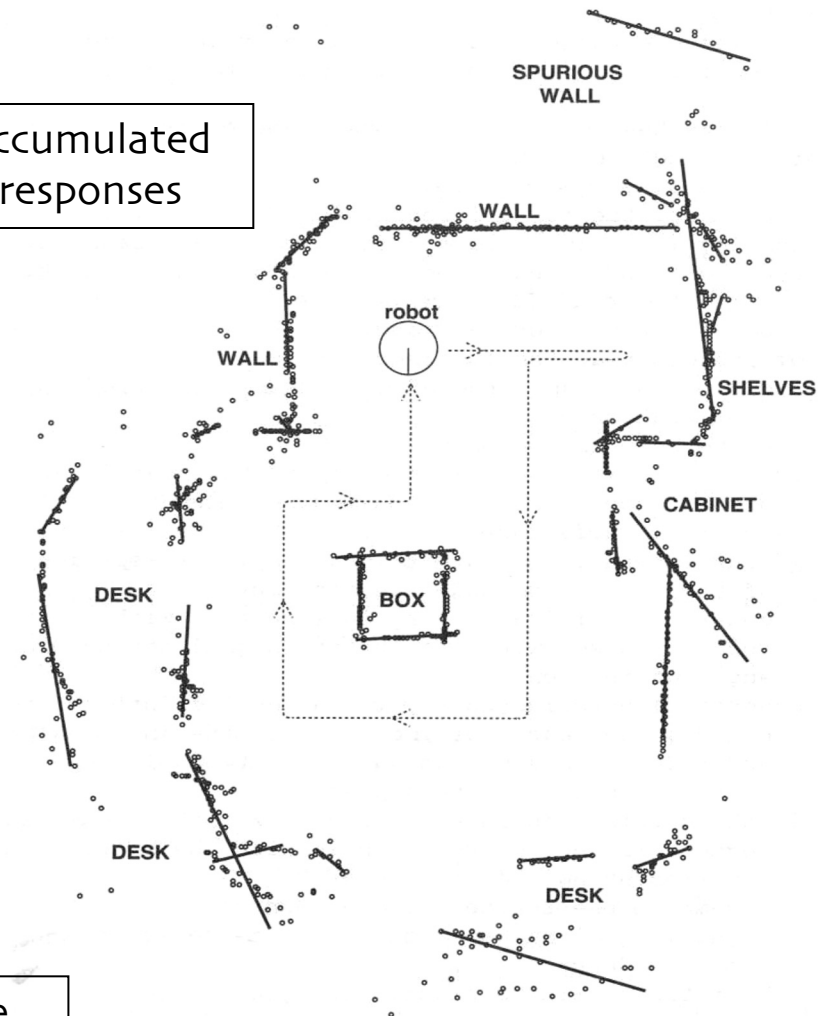

spatial response



# Sonar Modeling

response model (Kuc)

$$h_R(t, z, a, \alpha) = \frac{2c \cos \alpha}{\pi a \sin \alpha} \sqrt{1 - \frac{c^2(t - 2z/c)^2}{a^2 \sin^2 \alpha}}$$

sonar  
reading

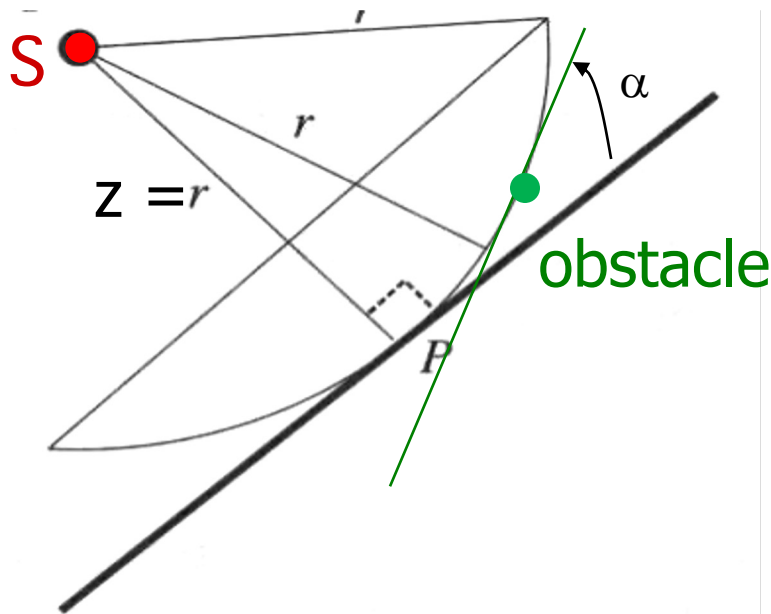

- Models the response,  $h_R$ , with:

$c$  = speed of sound

$a$  = diameter of sonar element

$t$  = time

$z$  = orthogonal distance

$\alpha$  = angle of environment surface

- Then, add noise to the model to obtain a probability:  $p(S | o)$

chance that the sonar reading is  $S$ ,  
given an obstacle at location  $O$





# Using sonar to create maps

---

What should we conclude if this sonar reads 10 feet?

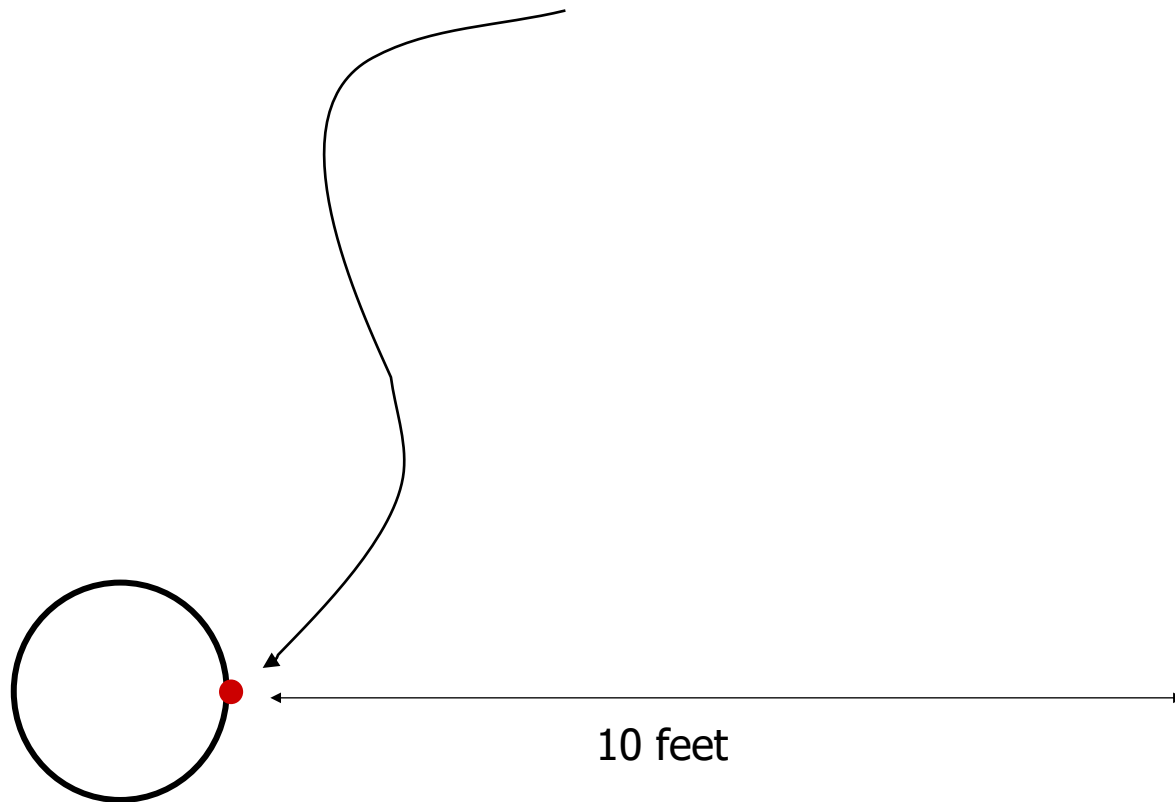

# Using sonar to create maps

What should we conclude if this sonar reads 10 feet?

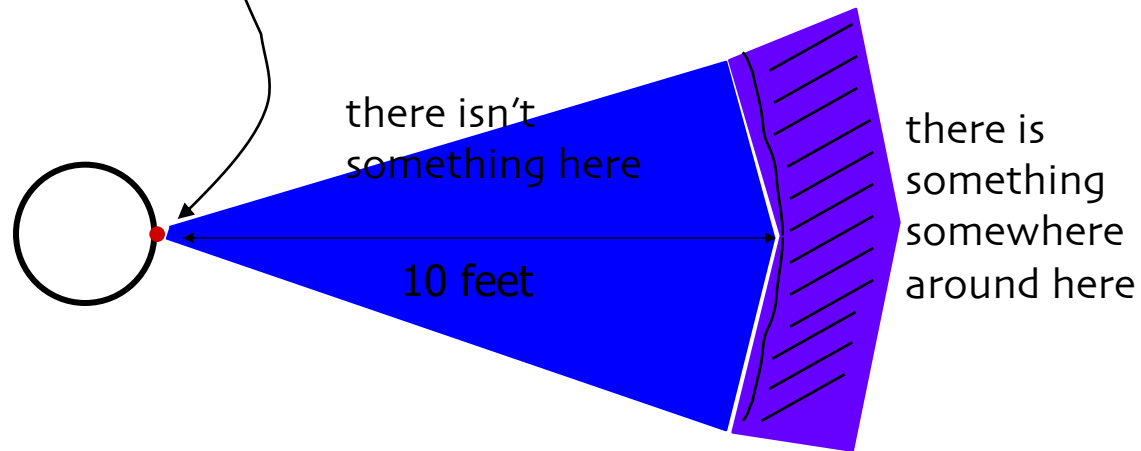



**Local Map**  
■ unoccupied  
■ occupied

# Using sonar to create maps

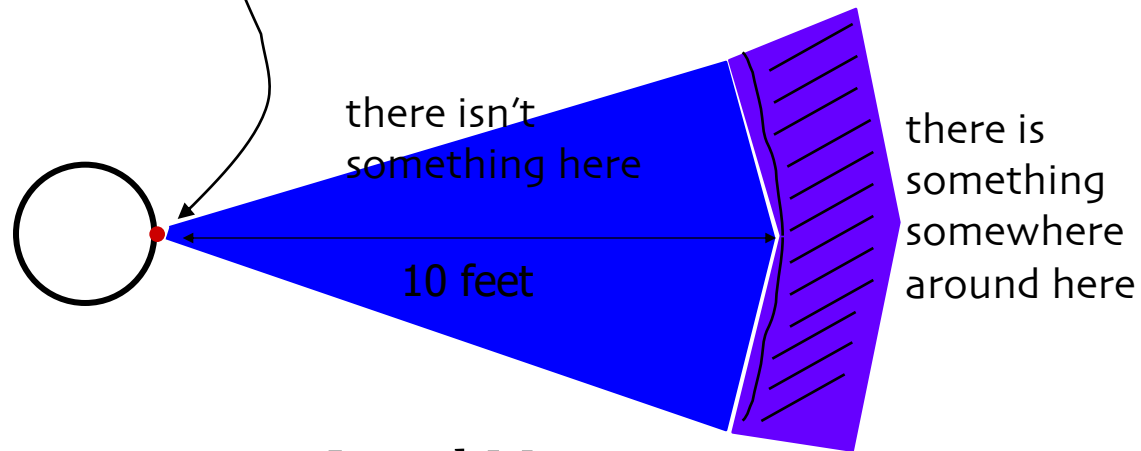
What should we conclude if this sonar reads 10 feet?



## Local Map

-  unoccupied
-  no information
-  occupied

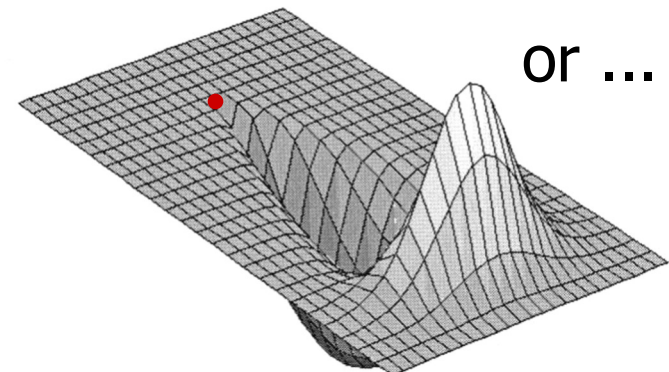

# Using sonar to create maps

What should we conclude if this sonar reads 10 feet...

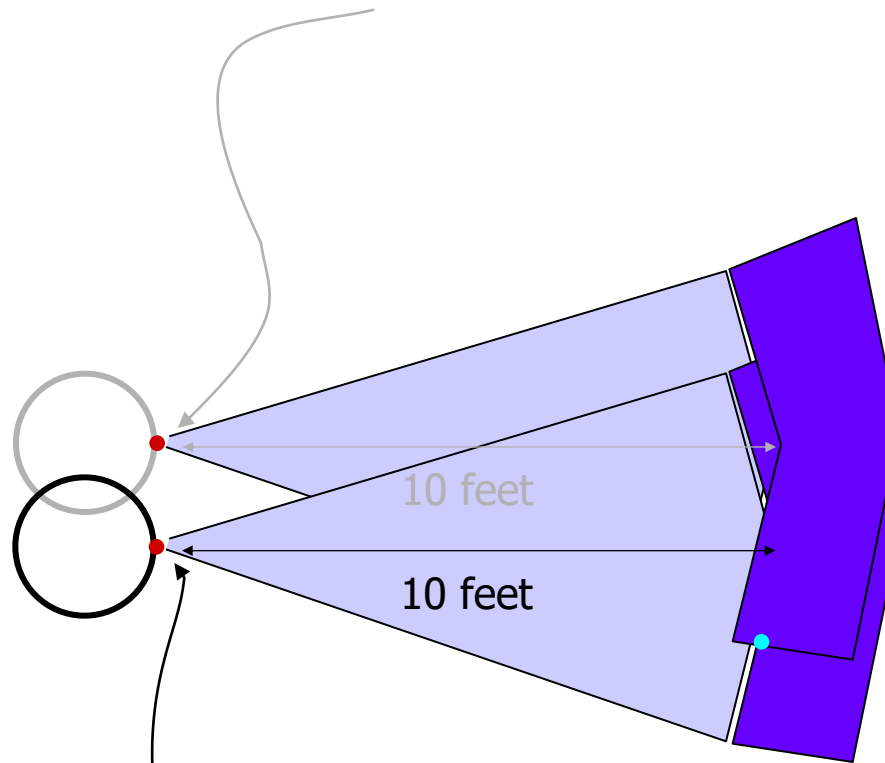

and how do we add the information that the next sonar reading (as the robot moves) reads 10 feet, too?



# Combining sensor readings

- The key to making accurate maps is combining lots of data.
- But combining these numbers means we have to know what they are !

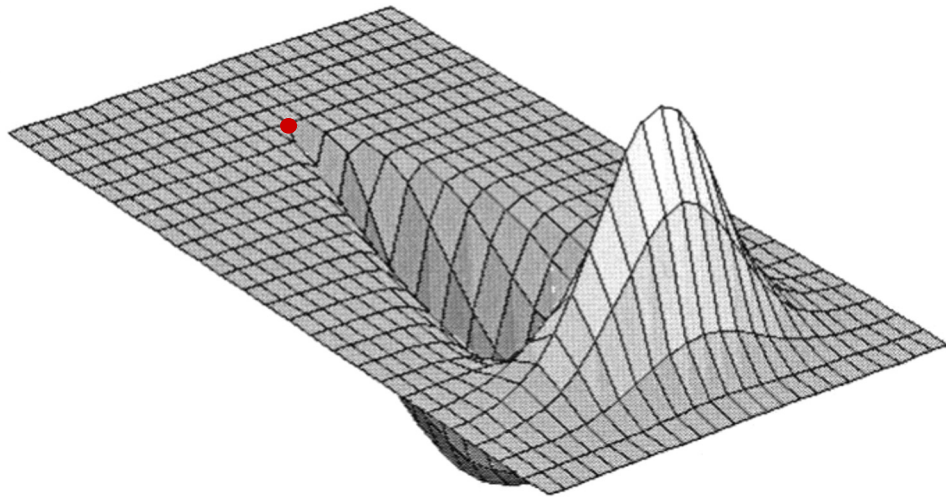

what is in each cell of this sonar model / map ?

## What should our map contain ?

- small cells
- each represents a bit of the robot's environment
- larger values => obstacle
- smaller values => free

# What is it a map of?

Several answers to this question have been tried:

It's a map of occupied cells.

pre '83

$O_{xy}$  cell (x,y) is occupied

$\bar{O}_{xy}$  cell (x,y) is unoccupied

Each cell is either occupied or unoccupied -- this was the approach taken by the Stanford Cart.

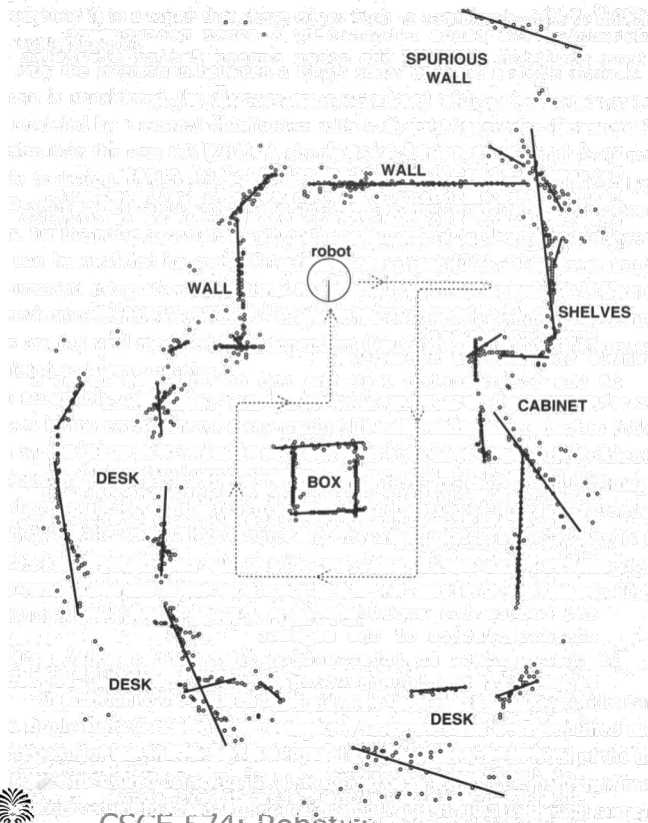

What information **should** this map contain, given that it is created with sonar ?



# What is it a map of ?

Several answers to this question have been tried:

pre '83 It's a map of occupied cells.  $O_{xy}$  cell (x,y) is occupied  $\bar{O}_{xy}$  cell (x,y) is unoccupied

---

'83 - '88 It's a map of probabilities:  $p(o | S_{1..i})$  The certainty that a cell is **occupied**, given the sensor readings  $S_1, S_2, \dots, S_i$   
 $p(\bar{o} | S_{1..i})$  The certainty that a cell is **unoccupied**, given the sensor readings  $S_1, S_2, \dots, S_i$

- maintaining related values separately?
- initialize all certainty values to zero
- contradictory information will lead to both values near 1
- combining them takes some work...



# Sonars from P/S

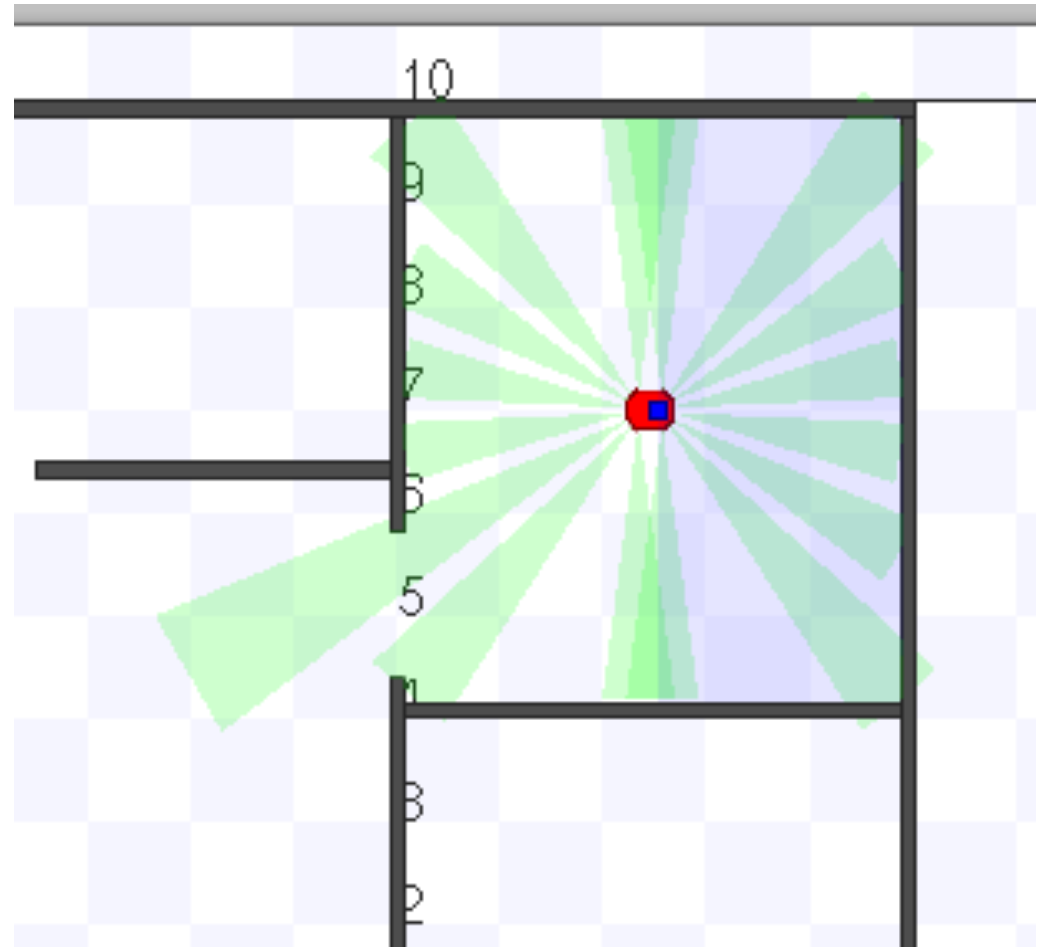
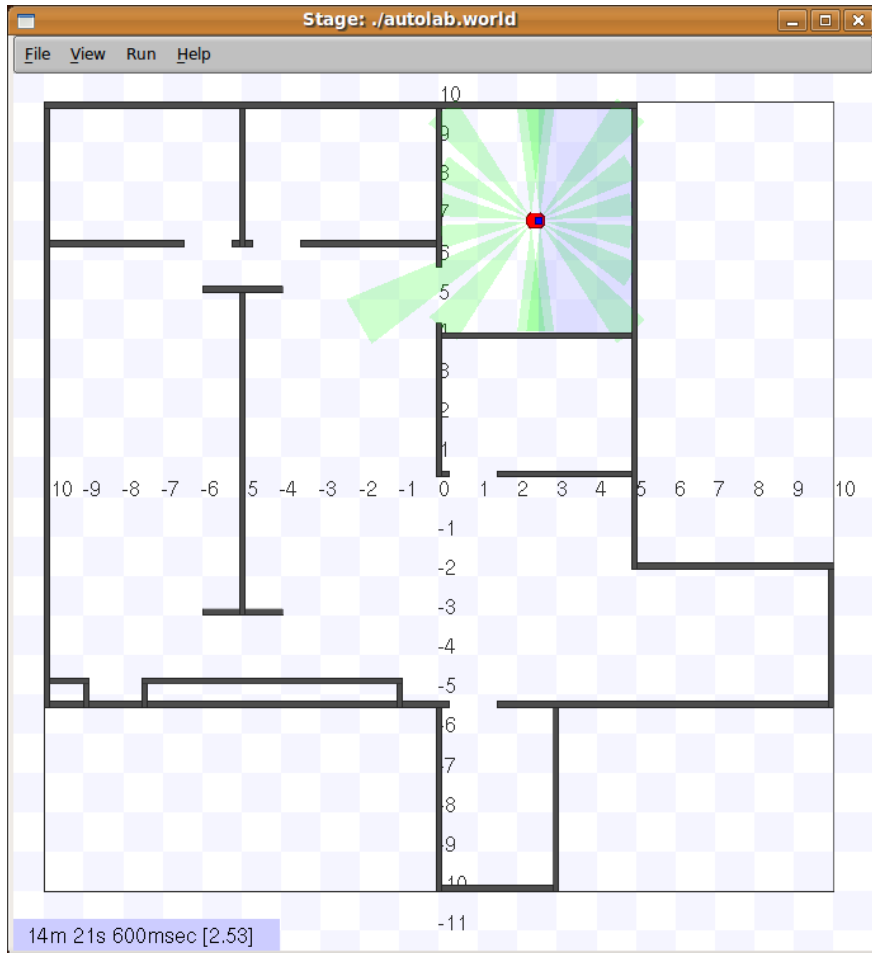



# Sonar Locations Pioneer 3DX Robot

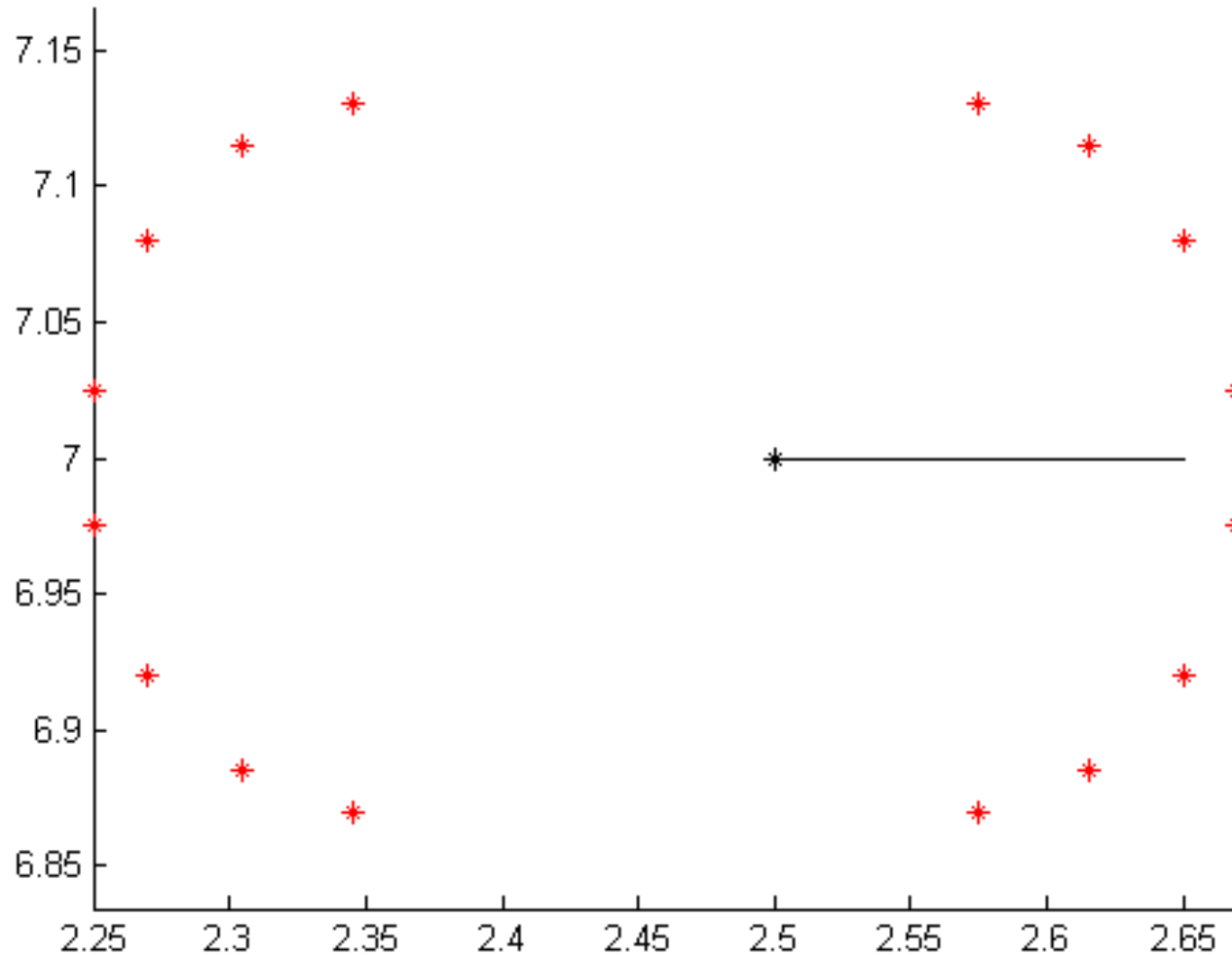

# Sonar Data Calculation

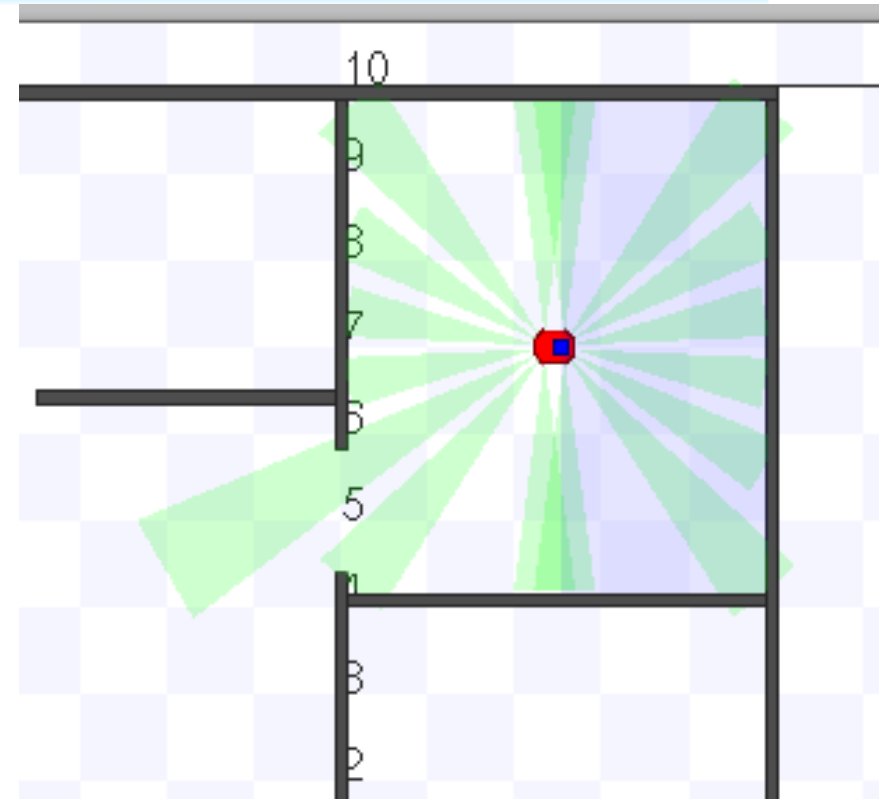
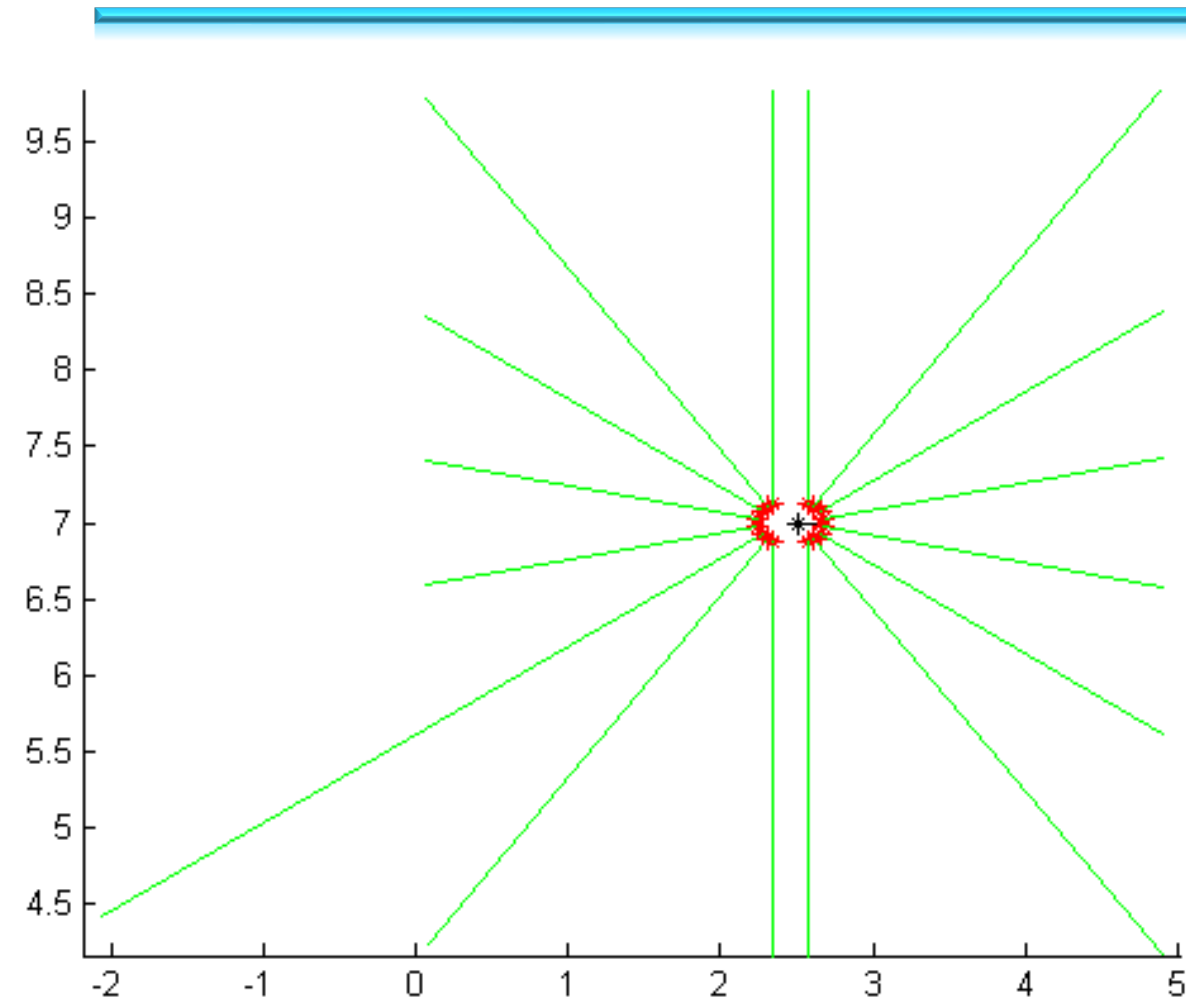

# Combining probabilities

---

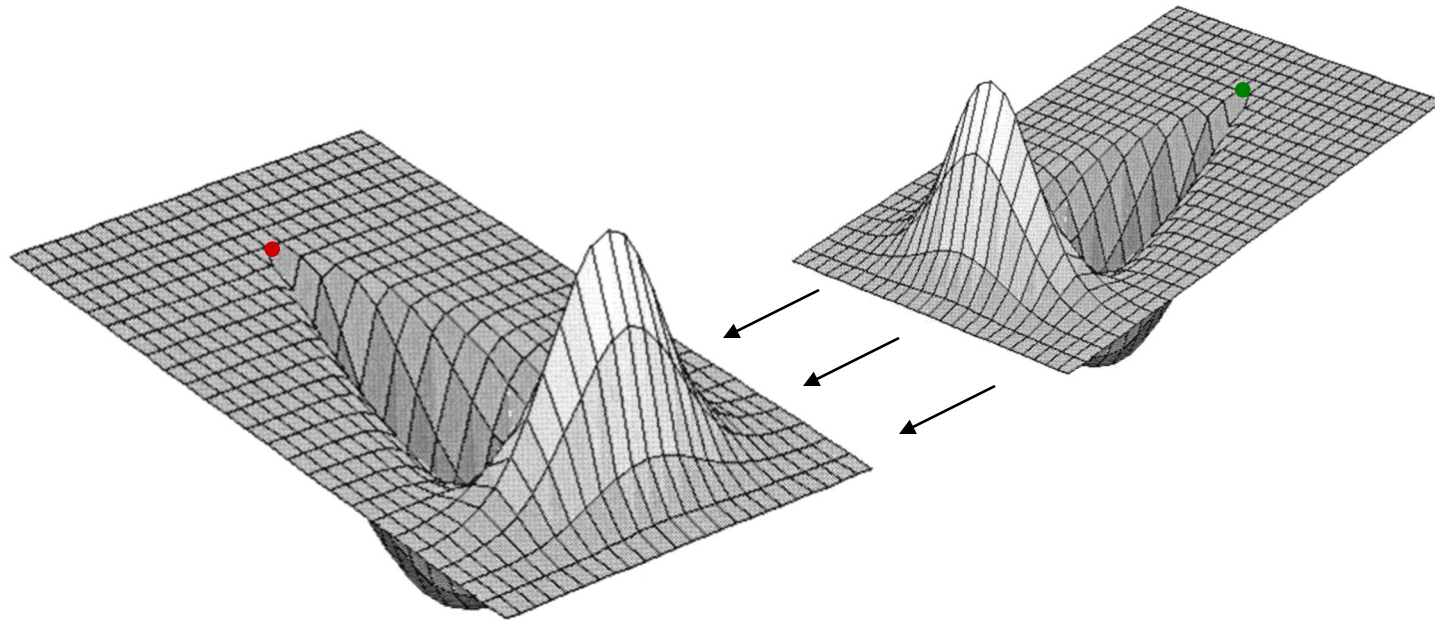

How to combine two sets of probabilities into a single map ?

# What is it a map of ?

Several answers to this question have been tried:

pre '83 It's a map of occupied cells.  $o_{xy}$  cell (x,y) is occupied  $\bar{o}_{xy}$  cell (x,y) is unoccupied

---

'83 - '88 It's a map of probabilities:  $p(o | S_{1..i})$  The certainty that a cell is **occupied**, given the sensor readings  $S_1, S_2, \dots, S_i$   
 $p(\bar{o} | S_{1..i})$  The certainty that a cell is **unoccupied**, given the sensor readings  $S_1, S_2, \dots, S_i$

---

★ It's a map of *odds*. The odds of an event are expressed *relative to the complement* of that event.

The odds that a cell is **occupied**, given the sensor readings  $S_1, S_2, \dots, S_i$   $odds(o | S_{1..i}) = \frac{p(o | S_{1..i})}{p(\bar{o} | S_{1..i})}$  probabilities



# An example map

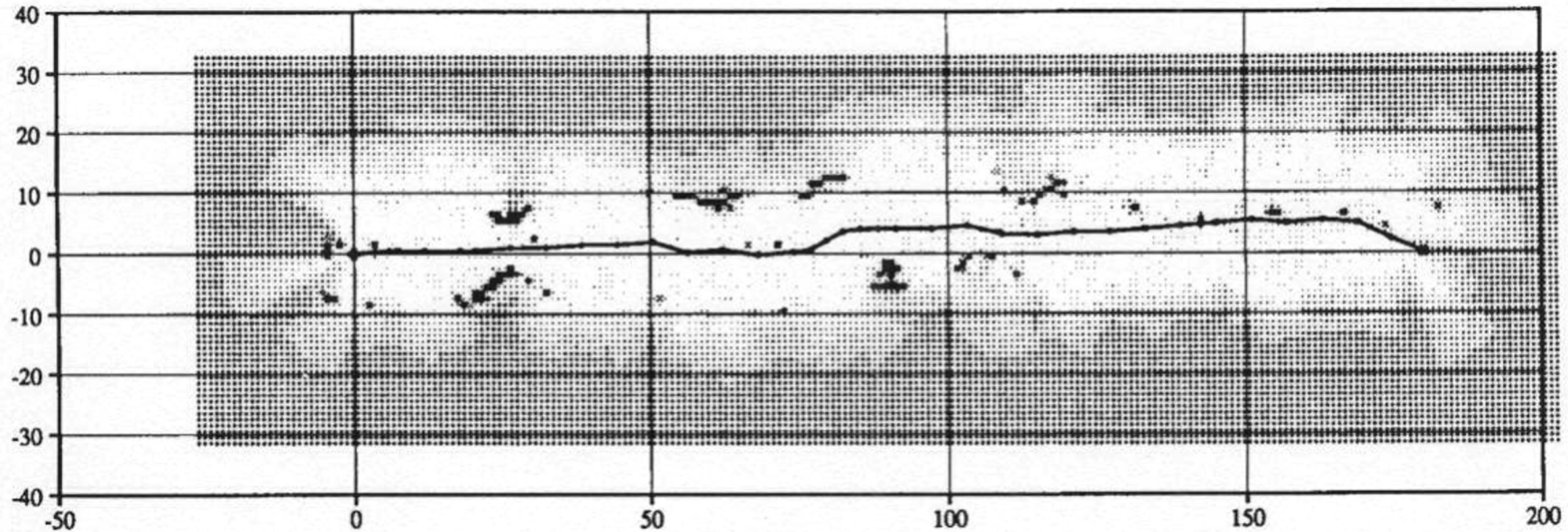

units: feet

Evidence grid of a tree-lined outdoor path

- lighter areas: *lower* odds of obstacles being present
- darker areas: *higher* odds of obstacles being present

how to combine them?



# Conditional probability

---

Some intuition...

$$p(o | S) = \frac{\text{The probability of event } o, \text{ given event } S.}{\text{The probability that a certain cell } o \text{ is occupied, given that the robot sees the sensor reading } S.}$$

---

$$p(S | o) = \frac{\text{The probability of event } S, \text{ given event } o.}{\text{The probability that the robot sees the sensor reading } S, \text{ given that a certain cell } o \text{ is occupied.}}$$

- What is really meant by conditional probability ?
- How are these two probabilities related?



# Bayes Rule

---

- Conditional probabilities

$$p(o \wedge S) = p(o | S)p(S)$$



# Bayes Rule

---

- Conditional probabilities

$$p(o \wedge S) = p(o | S)p(S)$$

- Bayes rule relates conditional probabilities

$$p(o | S) = \frac{p(S | o)p(o)}{p(S)}$$

Bayes rule





# Bayes Rule

---

- Conditional probabilities

$$p(o \wedge S) = p(o | S)p(S)$$

- Bayes rule relates conditional probabilities

$$p(o | S) = \frac{p(S | o)p(o)}{p(S)}$$

Bayes rule

- So, what does this say about  $\text{odds}(o | S_2 \wedge S_1)$  ?

Can we update easily ?



# Combining evidence

---

So, how do we combine evidence to create a map?

What we want --

$$\text{odds}( o \mid S_2 \wedge S_1 )$$

the new value of a cell in the map  
after the sonar reading  $S_2$

---

What we know --

$$\text{odds}( o \mid S_1 )$$

the old value of a cell in the map  
(before sonar reading  $S_2$ )

$$p( S_i \mid o ) \ \& \ p( S_i \mid \bar{o} )$$

the probabilities that a certain obstacle  
causes the sonar reading  $S_i$



# Combining evidence

---

$$\text{odds}(o | S_2 \wedge S_1) = \frac{p(o | S_2 \wedge S_1)}{p(\bar{o} | S_2 \wedge S_1)}$$



# Combining evidence

---

$$\begin{aligned} \text{odds}(o | S_2 \wedge S_1) &= \frac{p(o | S_2 \wedge S_1)}{p(\bar{o} | S_2 \wedge S_1)} \\ &= \frac{p(S_2 \wedge S_1 | o)p(o)}{p(S_2 \wedge S_1 | \bar{o})p(\bar{o})} \end{aligned}$$

definition of odds



# Combining evidence

$$\text{odds}(o | S_2 \wedge S_1) = \frac{p(o | S_2 \wedge S_1)}{p(\bar{o} | S_2 \wedge S_1)}$$

definition of odds

$$= \frac{p(S_2 \wedge S_1 | o)p(o)}{p(S_2 \wedge S_1 | \bar{o})p(\bar{o})}$$

Bayes' rule (+)

$$= \frac{p(S_2 | o)p(S_1 | o)p(o)}{p(S_2 | \bar{o})p(S_1 | \bar{o})p(\bar{o})}$$



# Combining evidence

$$\text{odds}(o | S_2 \wedge S_1) = \frac{p(o | S_2 \wedge S_1)}{p(\bar{o} | S_2 \wedge S_1)}$$

definition of odds

$$= \frac{p(S_2 \wedge S_1 | o)p(o)}{p(S_2 \wedge S_1 | \bar{o})p(\bar{o})}$$

Bayes' rule (+)

$$= \frac{p(S_2 | o)p(S_1 | o)p(o)}{p(S_2 | \bar{o})p(S_1 | \bar{o})p(\bar{o})}$$

conditional  
independence of  
 $S_1$  and  $S_2$

$$= \frac{p(S_2 | o)p(o | S_1)}{p(S_2 | \bar{o})p(\bar{o} | S_1)}$$

Bayes' rule (+)



# Combining evidence

$$\text{odds}(o | S_2 \wedge S_1) = \frac{p(o | S_2 \wedge S_1)}{p(\bar{o} | S_2 \wedge S_1)}$$

definition of odds

$$= \frac{p(S_2 \wedge S_1 | o)p(o)}{p(S_2 \wedge S_1 | \bar{o})p(\bar{o})}$$

Bayes' rule (+)

$$= \frac{p(S_2 | o)p(S_1 | o)p(o)}{p(S_2 | \bar{o})p(S_1 | \bar{o})p(\bar{o})}$$

conditional independence of  $S_1$  and  $S_2$

$$= \frac{p(S_2 | o)p(o | S_1)}{p(S_2 | \bar{o})p(\bar{o} | S_1)}$$

Bayes' rule (+)

precomputed values

previous odds

the sensor model

Update step = multiplying the previous odds by a precomputed weight.



# Evidence grids

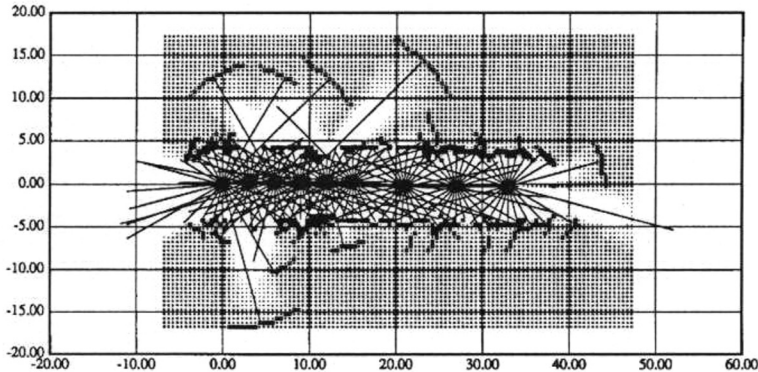

hallway with some open doors

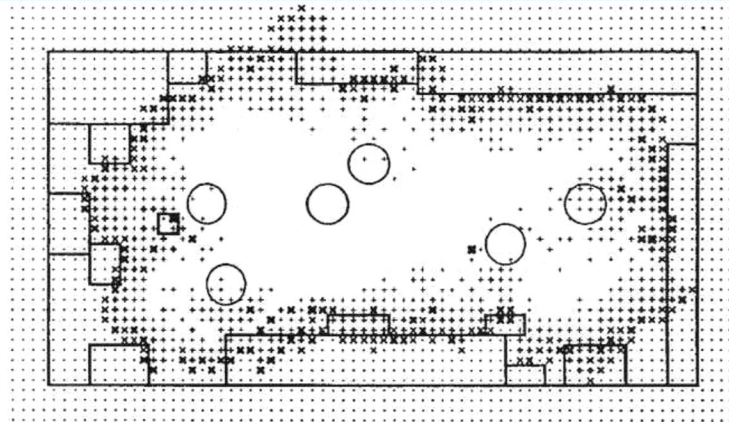

lab space

known map and estimated evidence grid

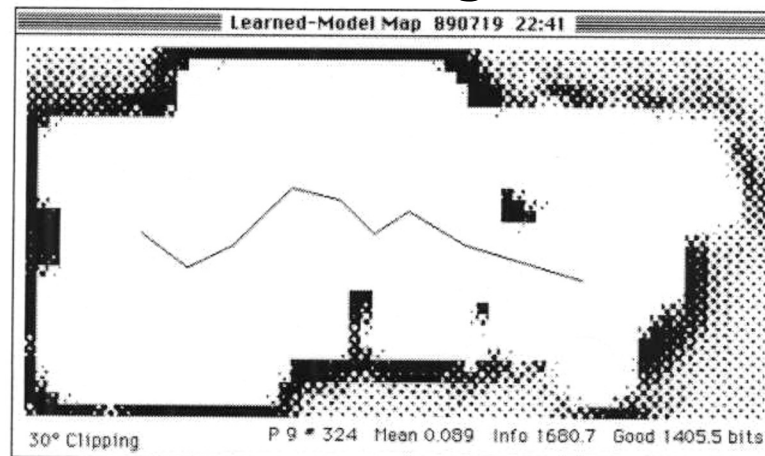
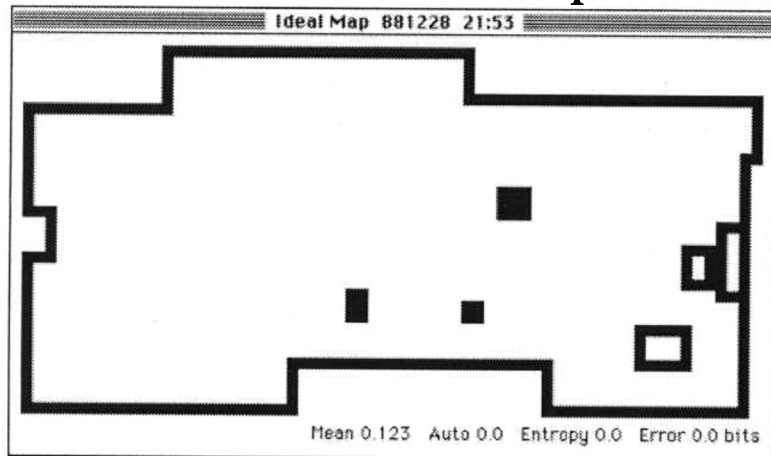



# Learning the Sensor Model

The sonar model depends dramatically on the environment  
-- we'd like to *learn* an appropriate sensor model

rather than hire Roman Kuc  
to develop another one...

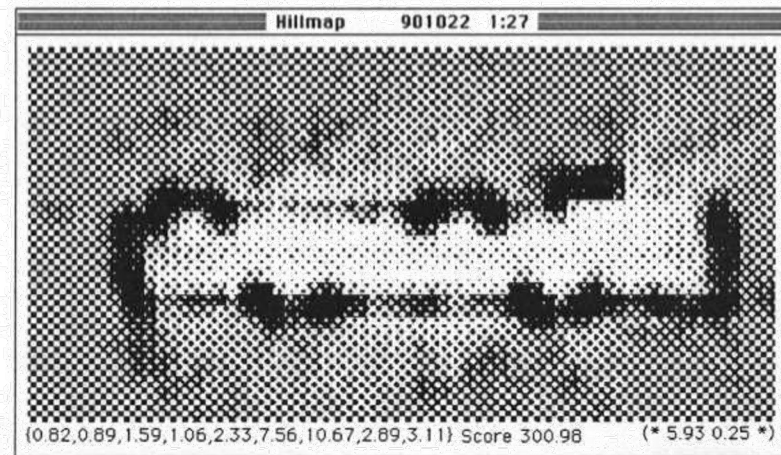
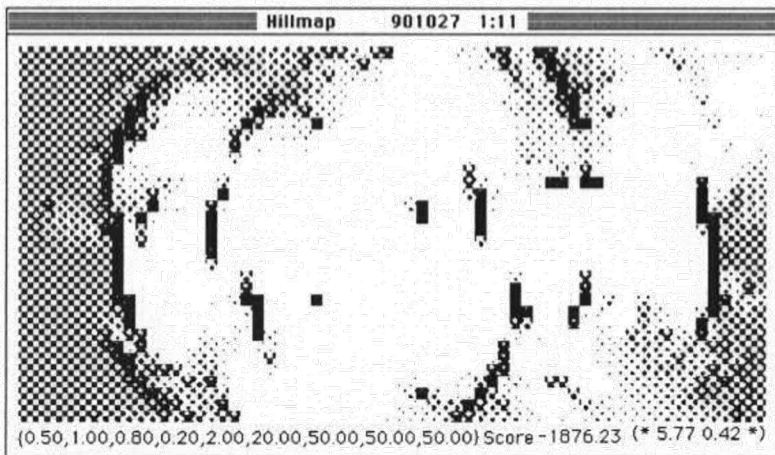
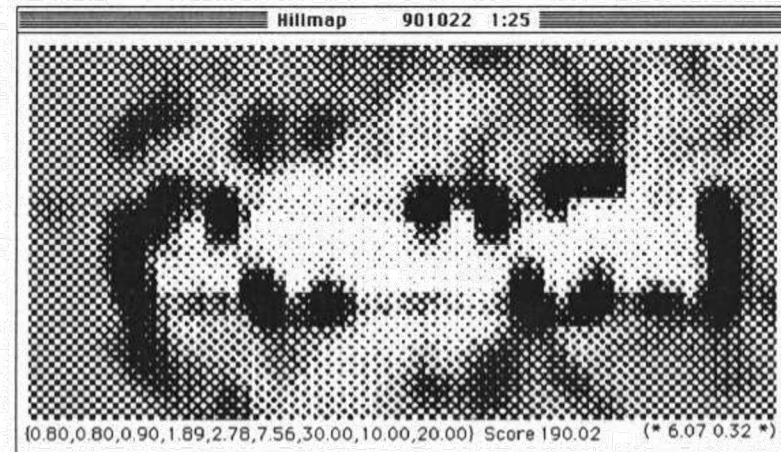
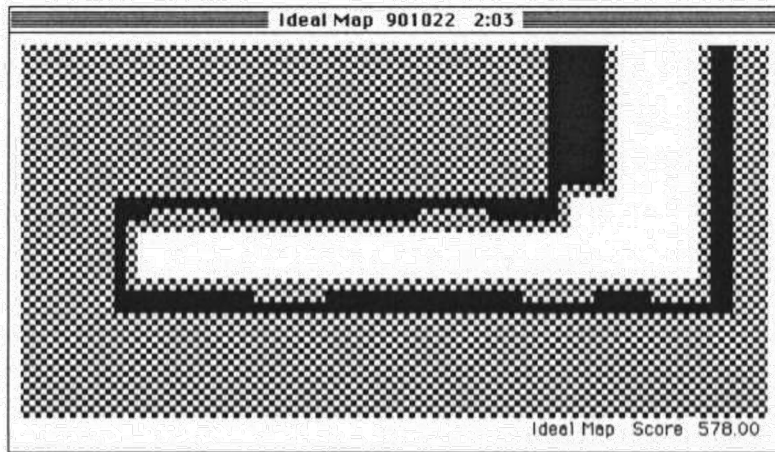

# Learning the Sensor Model

The sonar model depends dramatically on the environment  
-- we'd like to *learn* an appropriate sensor model

rather than hire Roman Kuc  
to develop another one...

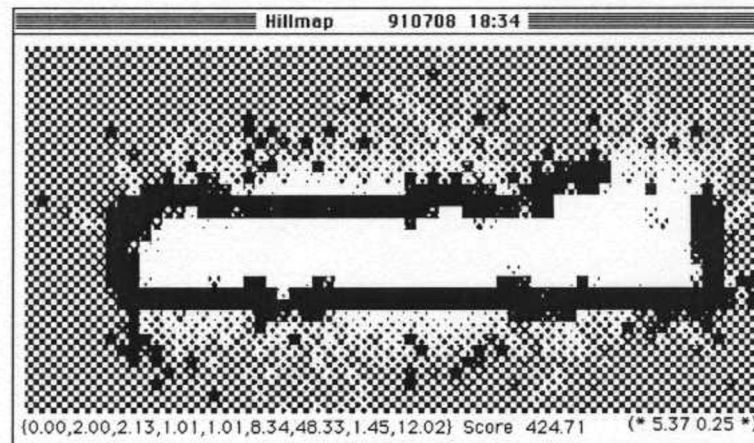
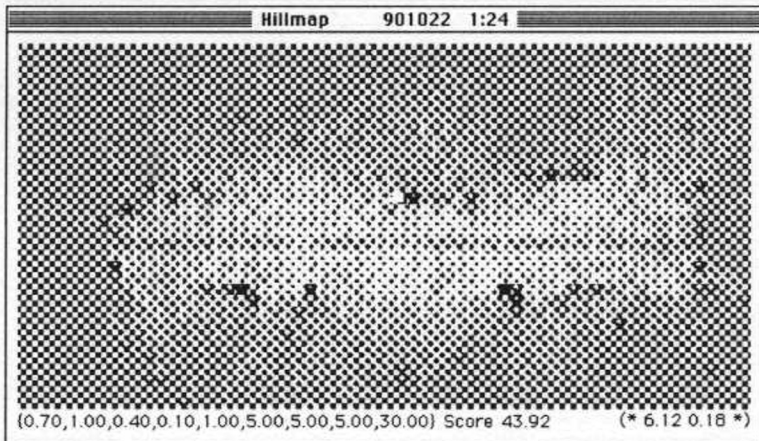
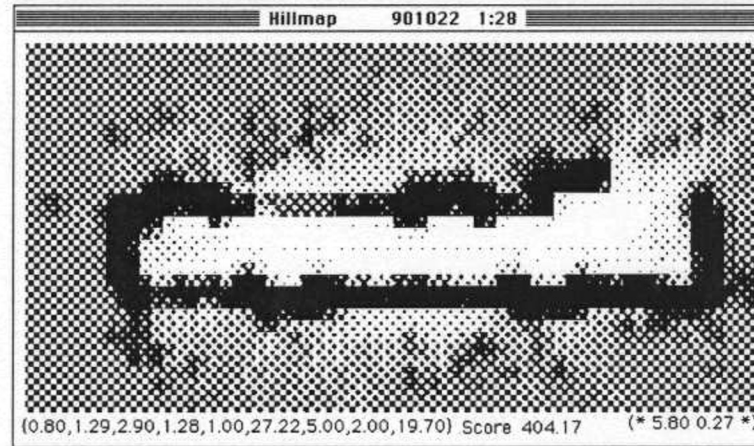
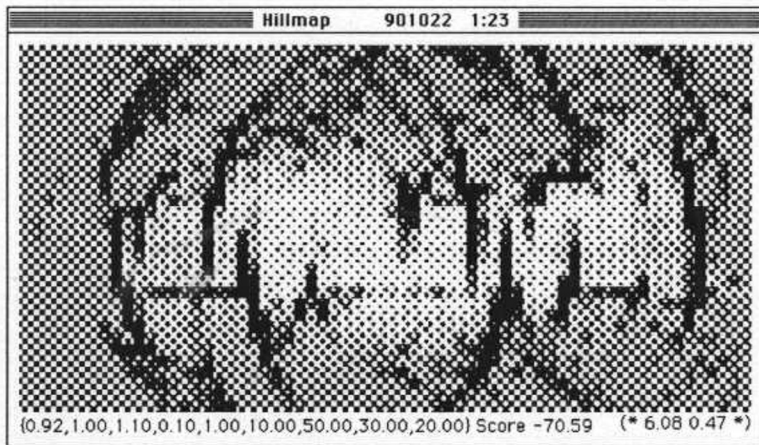

# Learning the Sensor Model

the idealized model

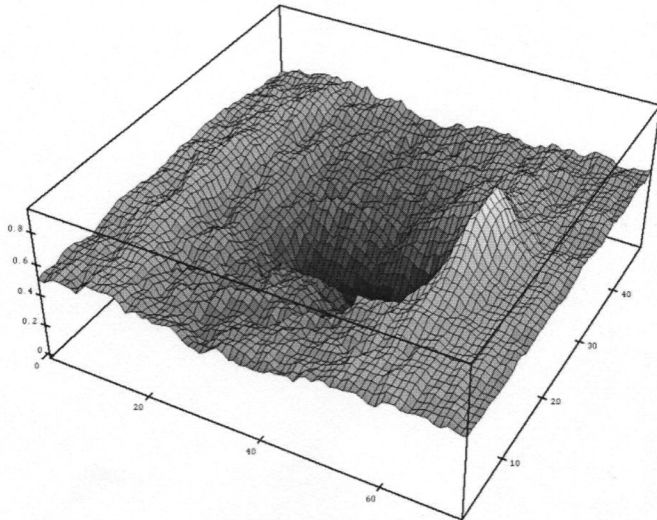
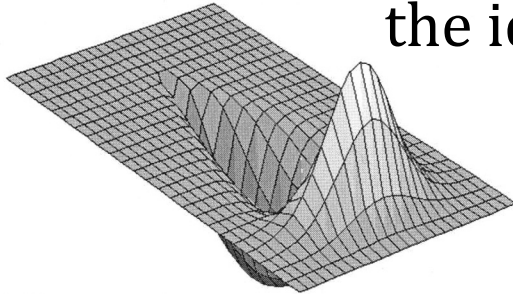

part of the learned model

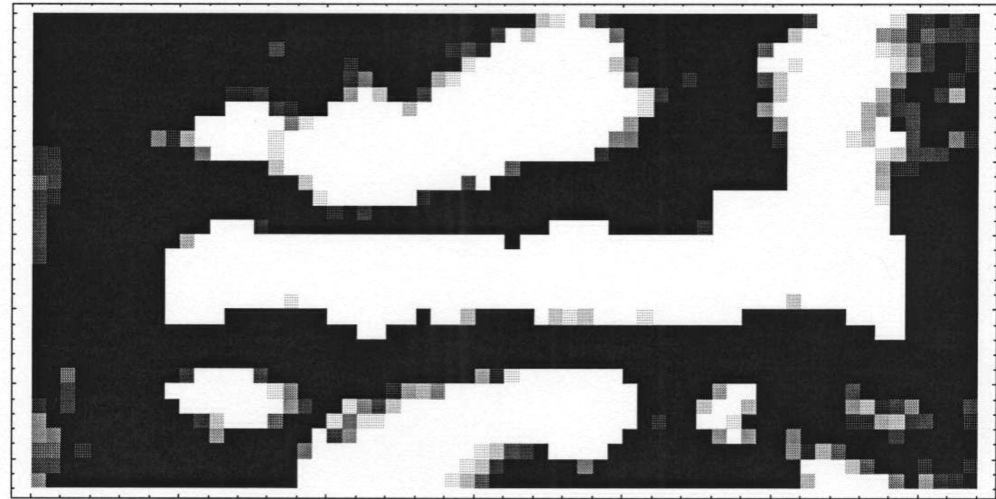

the mapping results of a model that had an even better match score (against the ideal map)

# Sensor fusion

Incorporating data from other sensors -- e.g., IR rangefinders and stereo vision...

- (1) create another sensor model
- (2) update along with the sonar

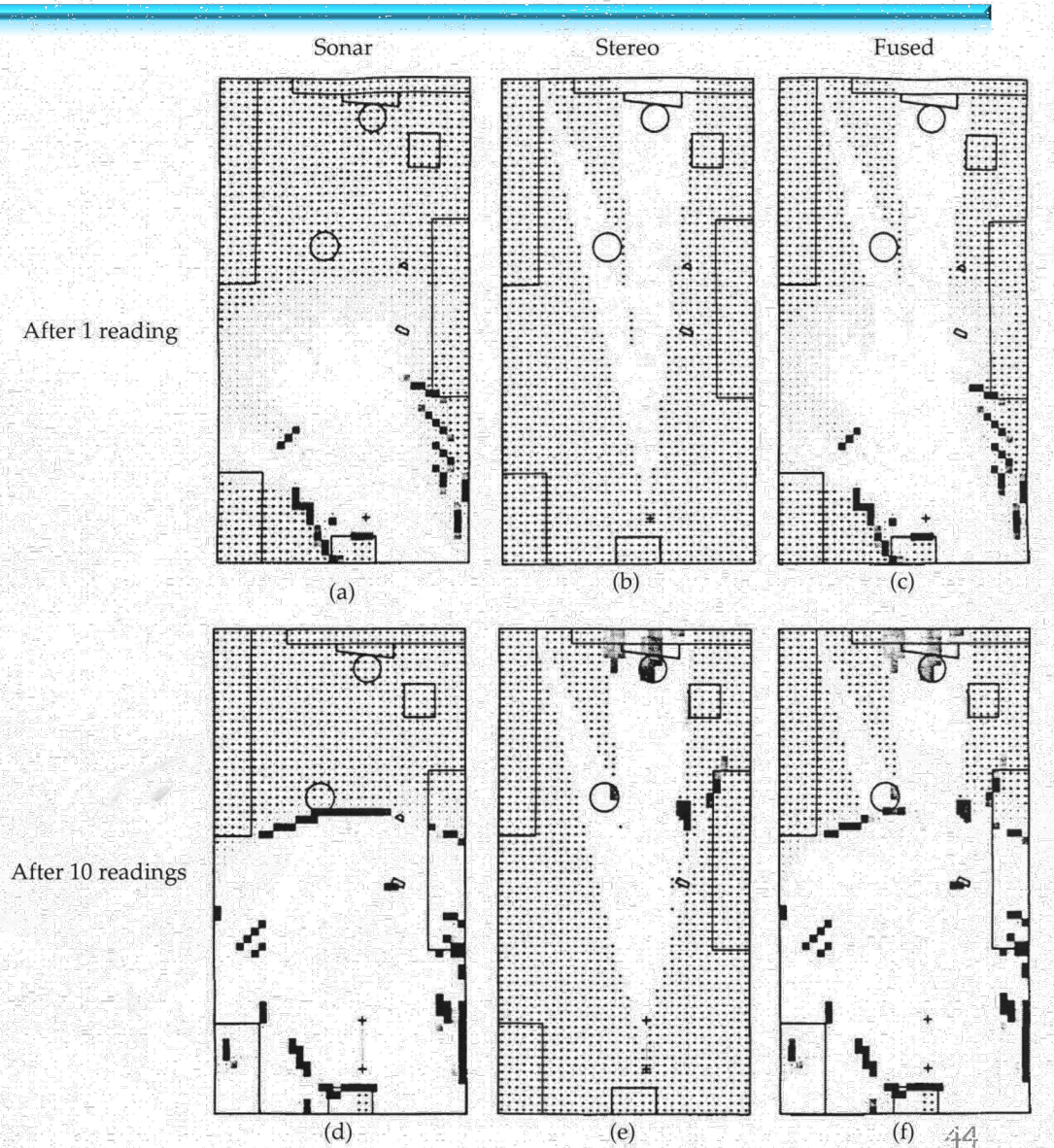

# Centerline

- Only consider region of significant response
- Approximate response with an arc of uniform probability

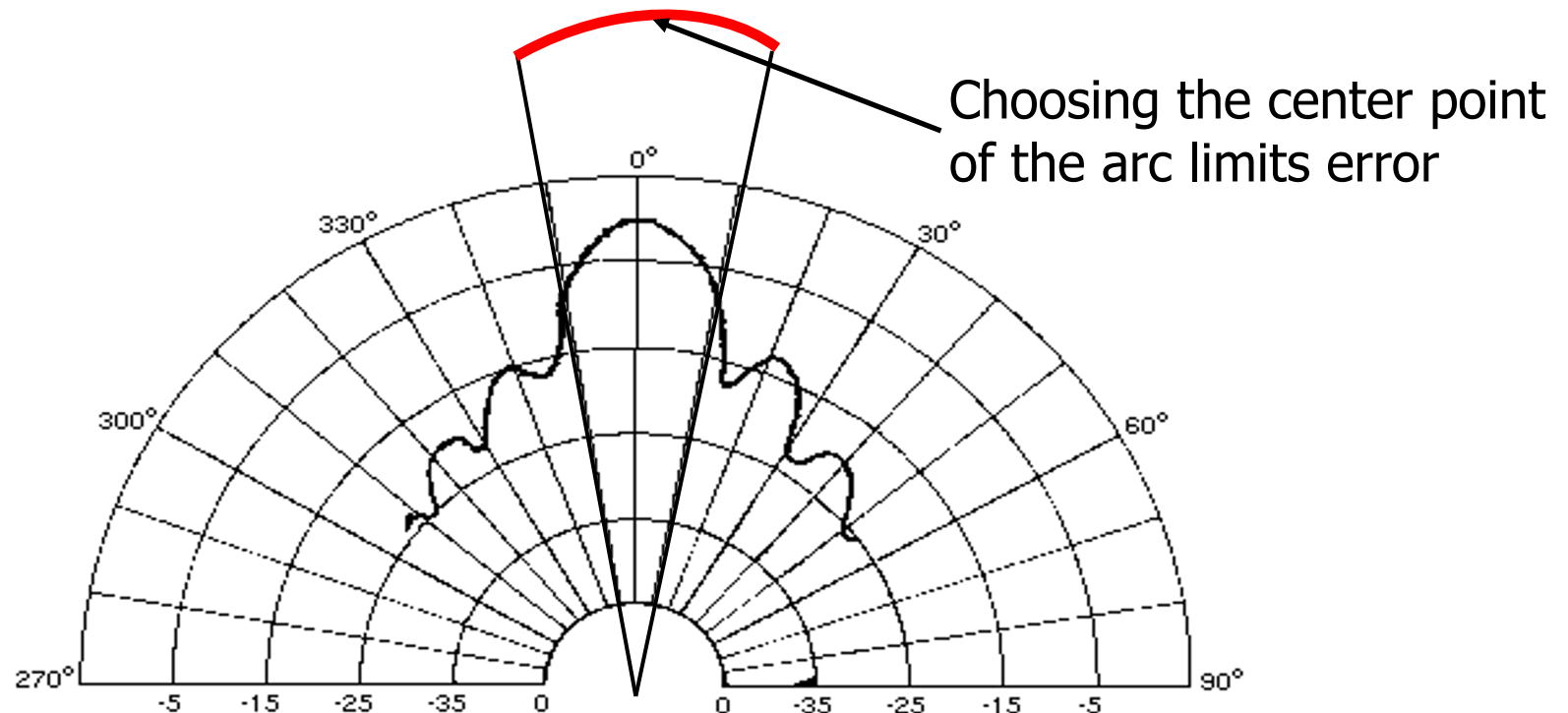

# Centerline

- Advantages
  - Minimal computation required per sonar reading
  - Low latency
- Disadvantages
  - Inaccurate
  - Open areas may appear occluded

only centerline points displayed

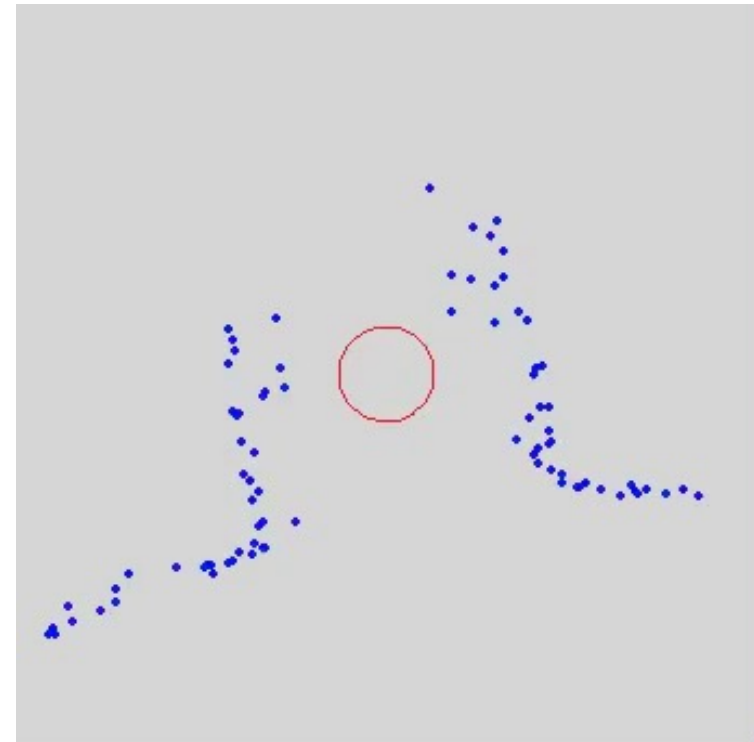

# Fusing Multiple Readings

---

- Regions of Constant Depth (RCDs)
  - Leonard et al. 1995
- Arc Tangents
  - McKerrow 1993
- Arc Transversal Median (ATM)
  - Choset and Nagatani 1999
- Line Fitting
  - MacKenzie and Dudek 1994



# Arc Carving Sonar Model

---

- Represents a sonar return as a cone with an arc base
  - The arc approximates the sonar response
  - The interior of the cone represents a region of likely freespace

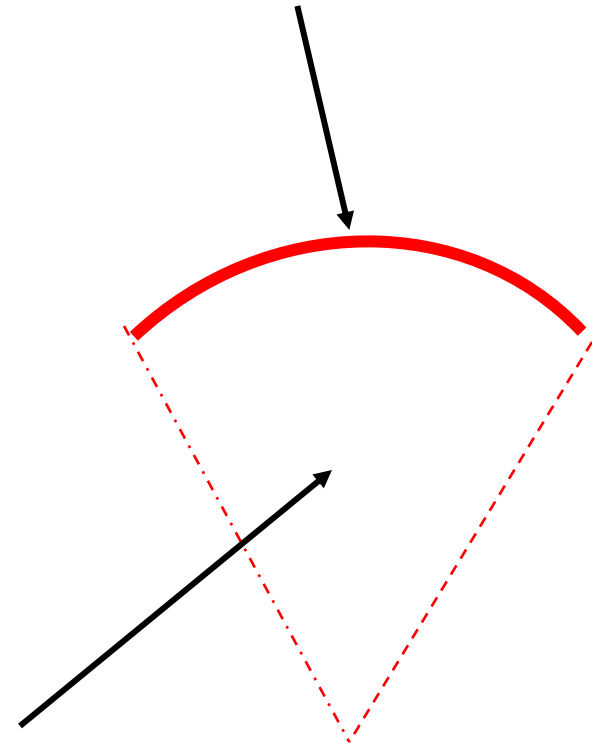



# Occupancy Grid Sonar Model

- The arc carving model may be viewed as a binary approximation of the model used by Moravec and Elfes
  - An Arc with nonzero probability of occupancy
  - A cone with nonzero probability of freespace

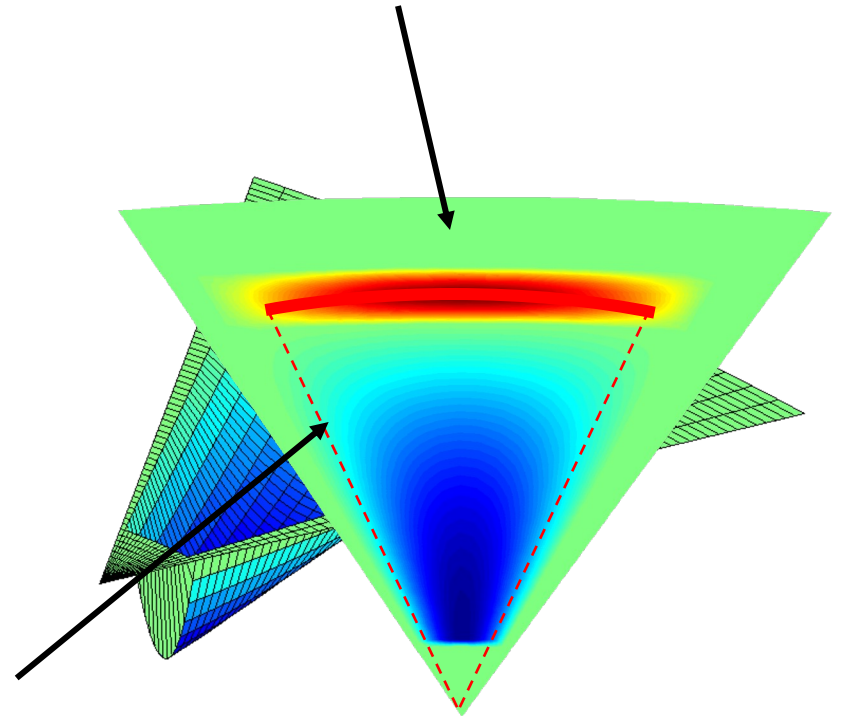

# Arc Carving

---

- Each new sonar reading is checked against a history of previous readings
- If an arc is overlapped by the interior of a newer cone, the arc is “carved” to reflect this new information
- The updated arc is smaller, and therefore has a smaller bound on the error

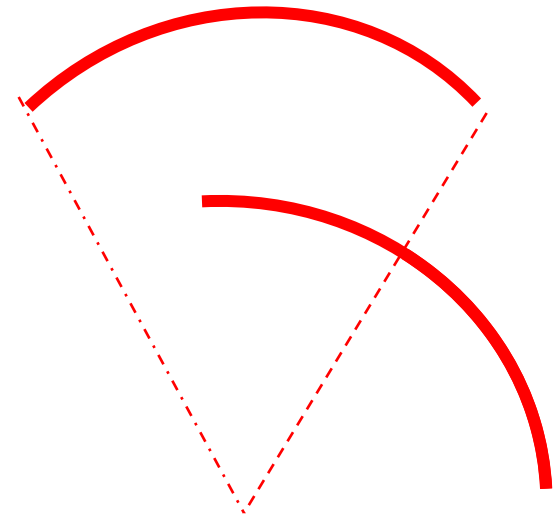

# Arc Carving

---

- Multiple passes of Arc Carving may completely remove an arc
  - Spurious sonar readings are removed
  - Response to dynamic environments is increased

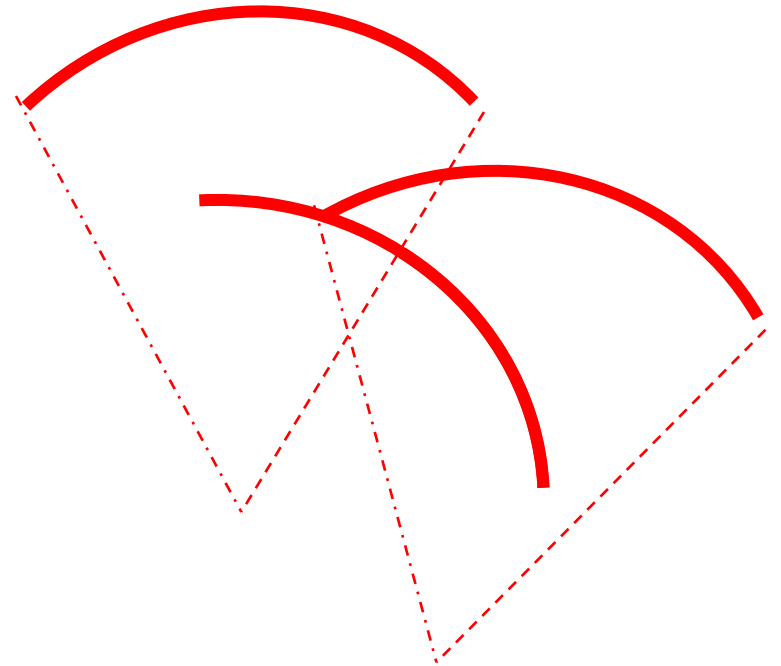

# Example – Ordinary Centerline

---

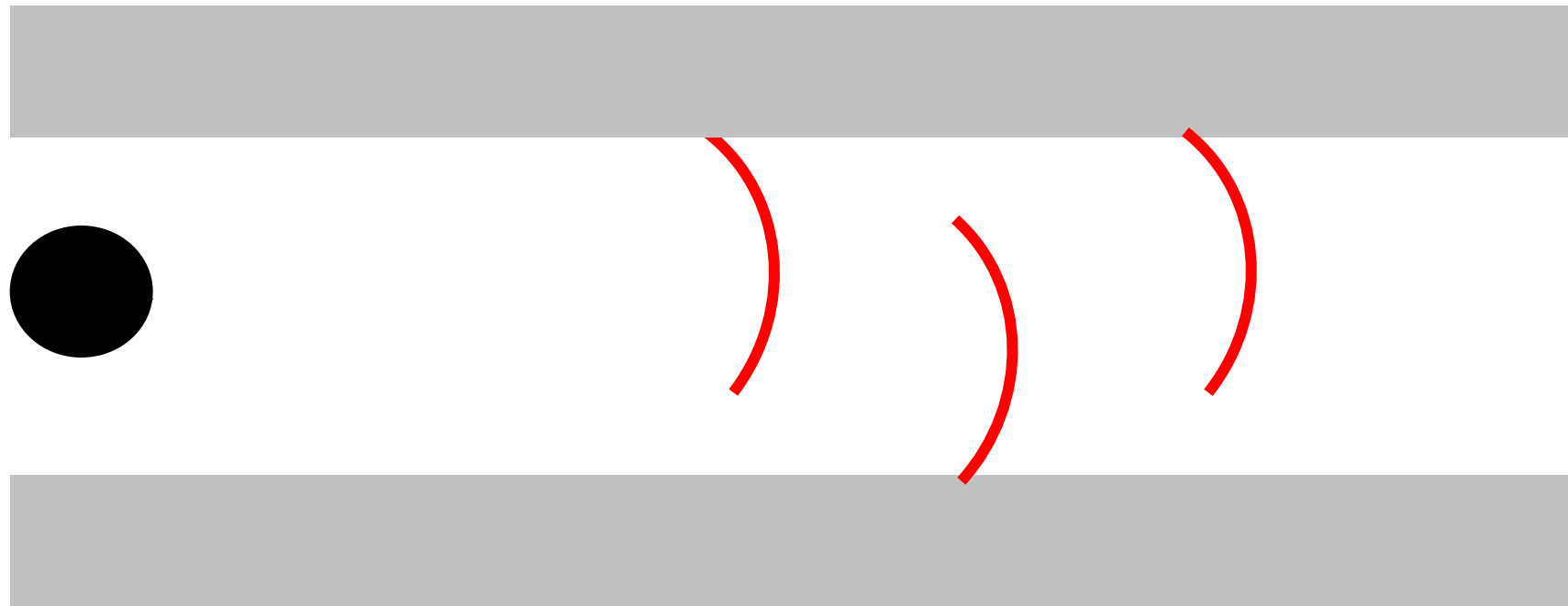

# Example – Arc Carving

---

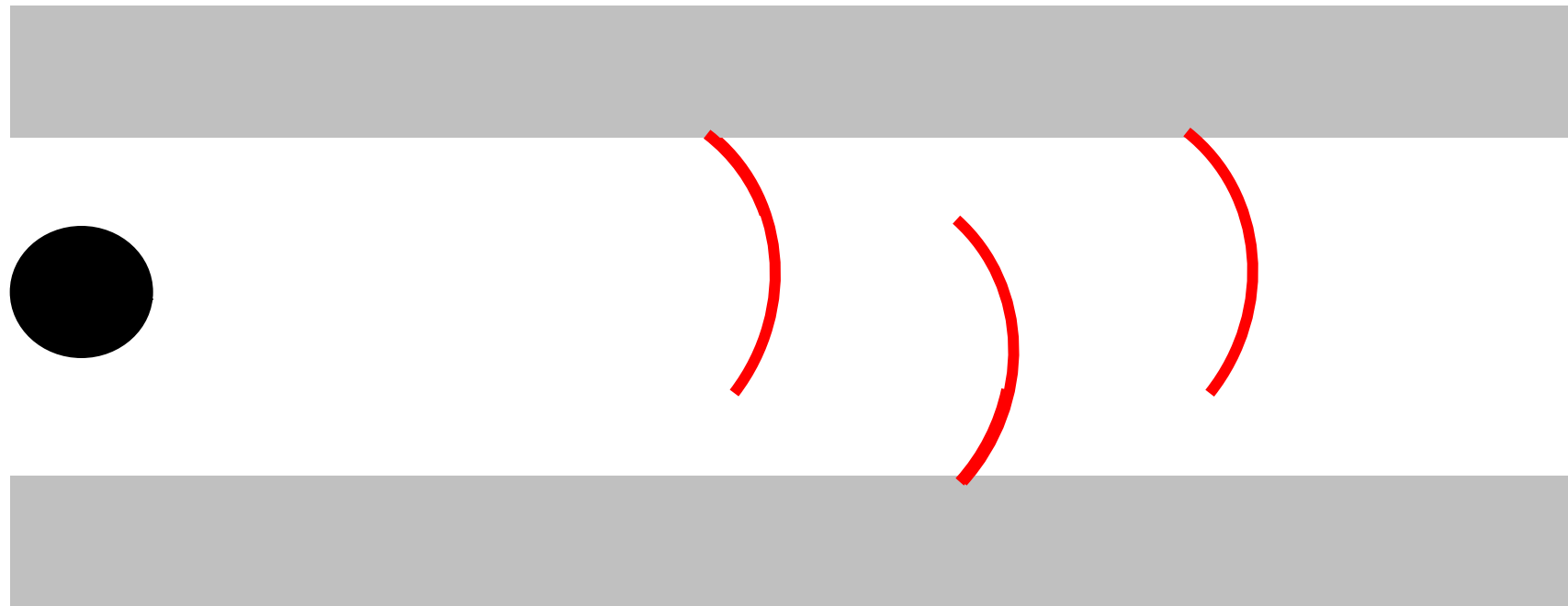

# Arc Carving Video

---

- Latency issues are avoided
- The readings are more accurate than centerline
- Multiple reading approaches can be run off of the carved data

only carved points displayed

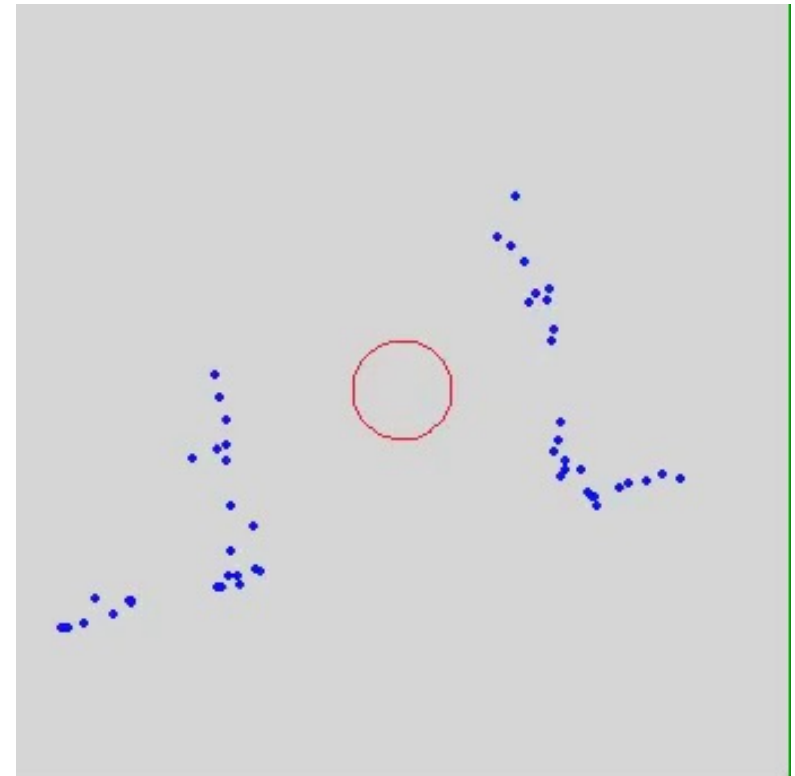

# Experimental Results: Centerline Map

---

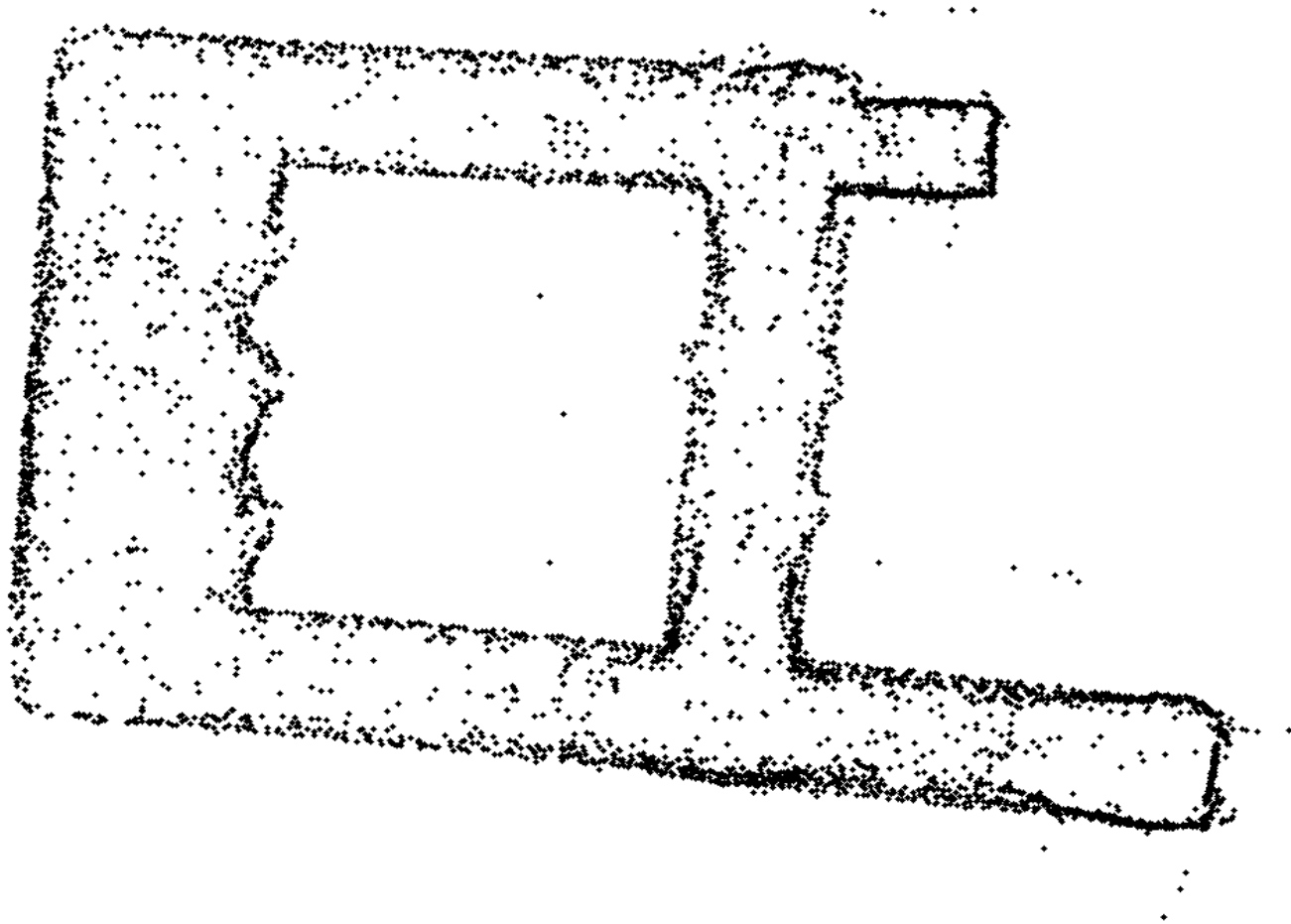

# Experimental Results: Arc Carving Map

---

