



UNIVERSITY OF
SOUTH CAROLINA

CSCE 574 ROBOTICS

History

Ioannis Rekleitis

Computer Science and Engineering

University of South Carolina

yiannisr@cse.sc.edu

Three Main Problems in Robotics

1. Where am I? (Localization)
2. What the world looks like? (Mapping)
 - Together 1 and 2 form the problem of *Simultaneous Localization and Mapping* (SLAM)
3. How do I go from **A** to **B**? (Path Planning)
 - More general: Which action should I pick next? (Planning)



Robot

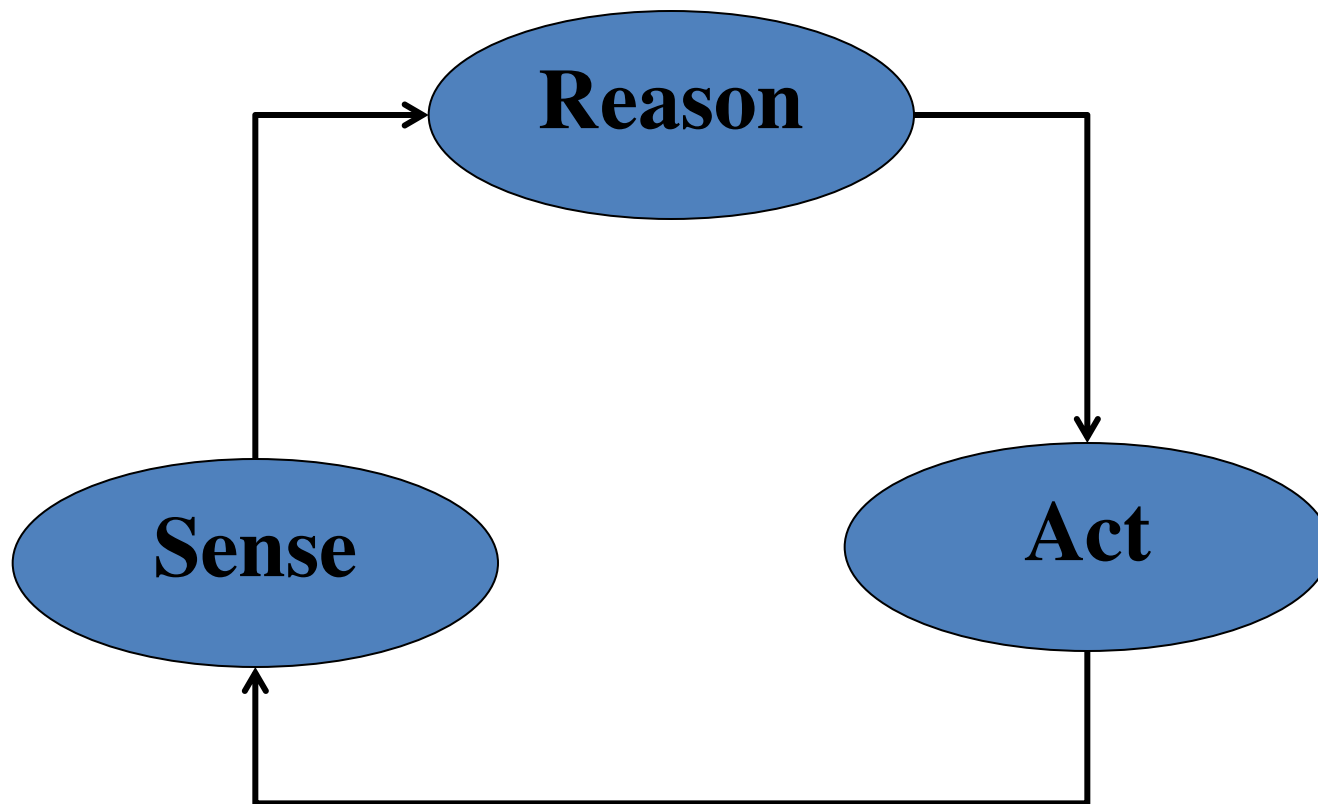

Talos (Τάλως/Τάλων) 400 BC

- A giant man of bronze who protected Europa in Crete, circling the island's shores three times daily while guarding it.
- Shore-length of Crete is 1.046 km.
- Average speed 130 Km/h



Automatons

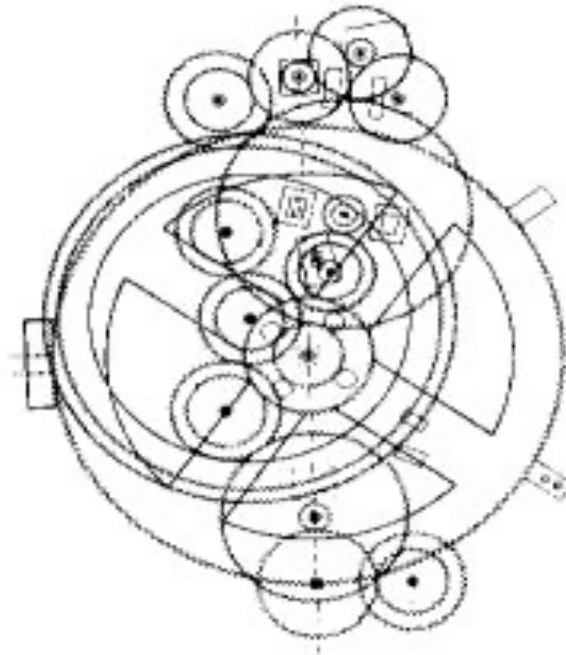

Antikythera, 150–100 BC

Heron of Alexandria (Ἡρῶν ὁ Ἀλεξανδρεὺς)

10-70AD



One of the first sensors:
Odometer.

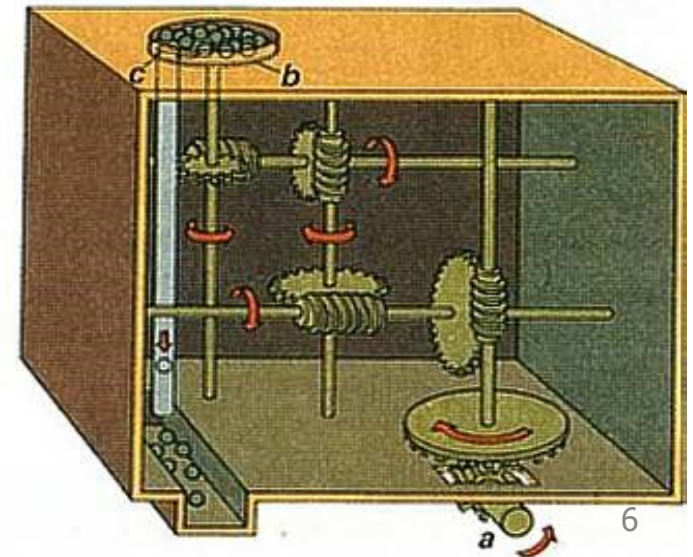

Heron of Alexandria

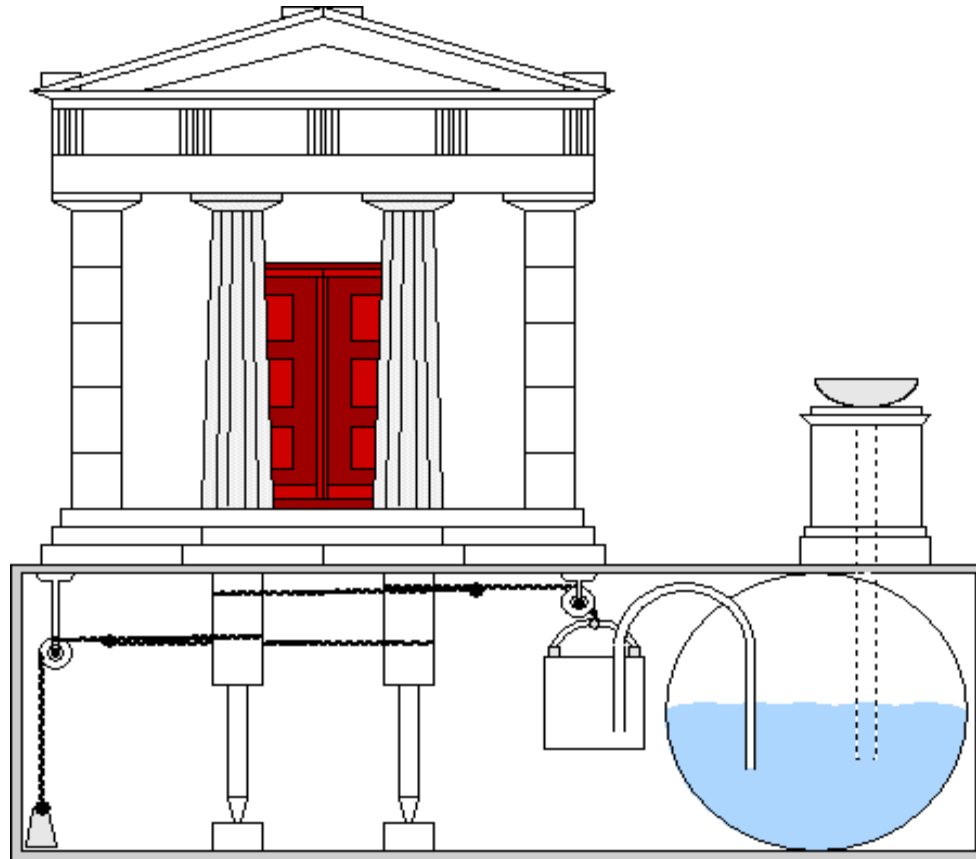

Automatons

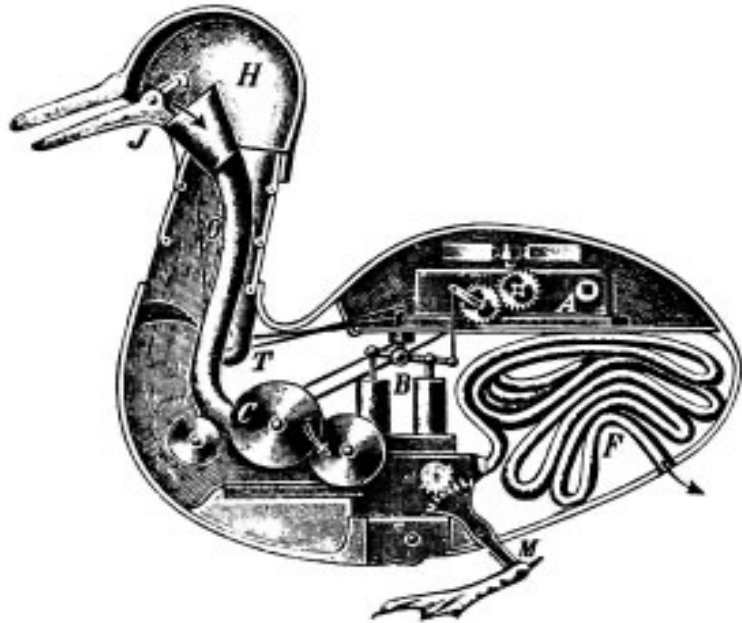

“Canard Digérateur”,
1793

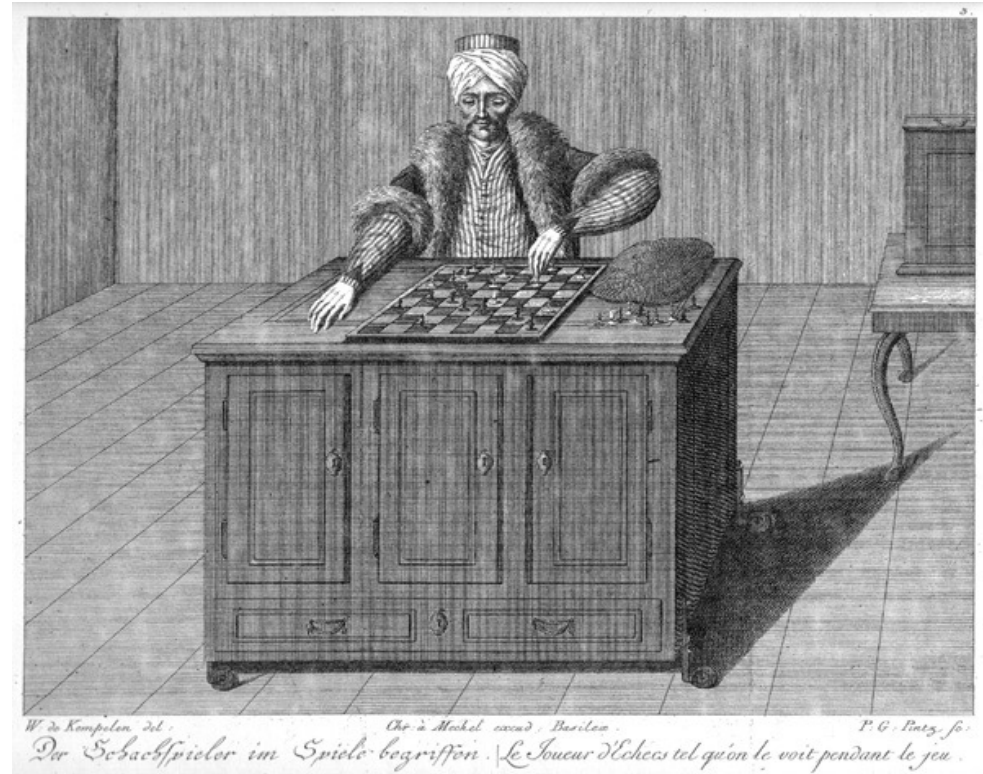

“The Turk”
1770

Tea serving automaton

19th Century, Japan



Word “Robot”

- “*Rossum's Universal Robots*” a novel by Karel Čapek, 1920.

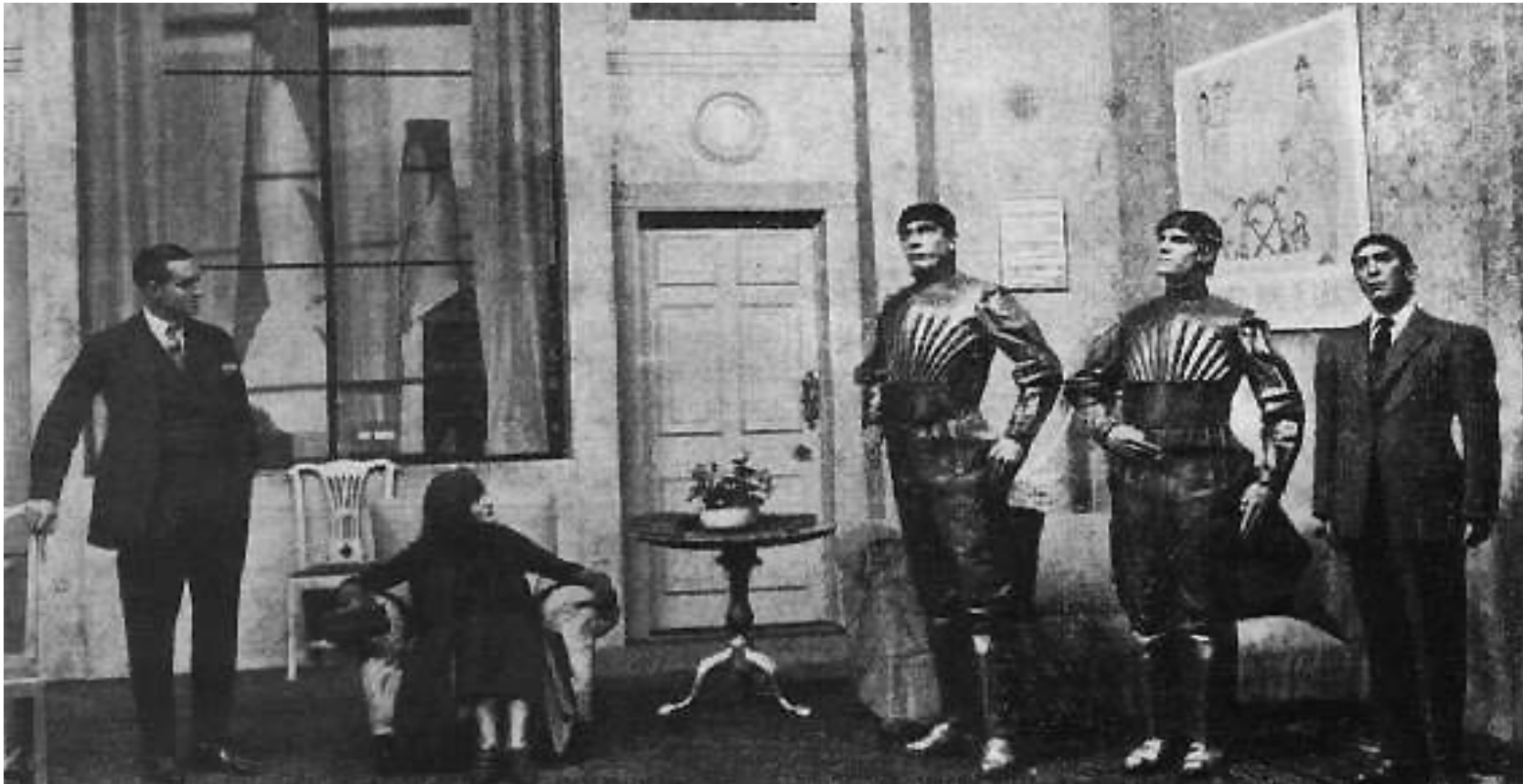

Mobile Robots: 1950

- Walter's *Tortoise*

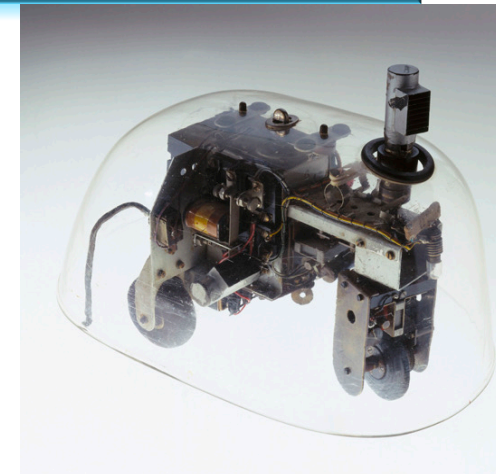

Source:
sciencemuseum.org.uk

<https://www.youtube.com/watch?v=wQE82derooc>

Shakey (1966 -1972)

- **Shakey** (Stanford Research Institute/SRI)
 - the first "autonomous" mobile robot to be operated using AI techniques
- Simple tasks to solve:
 - To recognize an object using vision, given a very restricted world
 - Find its way to the object
 - Perform some action on the object (for example, to push it over)
 - Perform compound actions and basic planning.

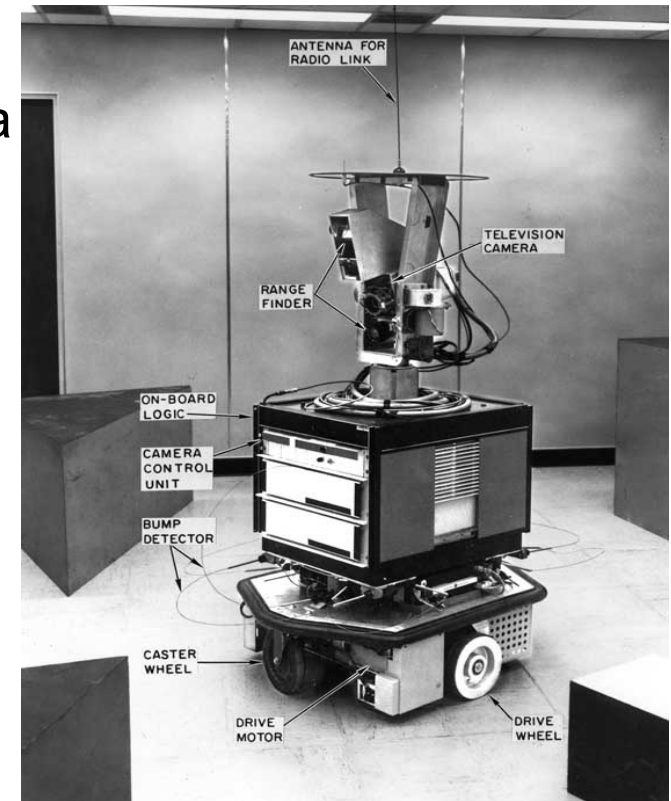

Stanford Cart



- 1973-1979
 - Stanford Cart developed by Hans Moravec
 - Use of stereo vision.
 - Took pictures from several different angles
 - The computer gauged the distance between the cart and obstacles in its path to do basic collision avoidance
 - About **15 min** to think about each image, then drives 1 foot or so.

Industrial history: 1961

June 13, 1961

G. C. DEVOL, JR

2,988,237

PROGRAMMED ARTICLE TRANSFER

Filed Dec. 10, 1954

3 Sheets-Sheet 1

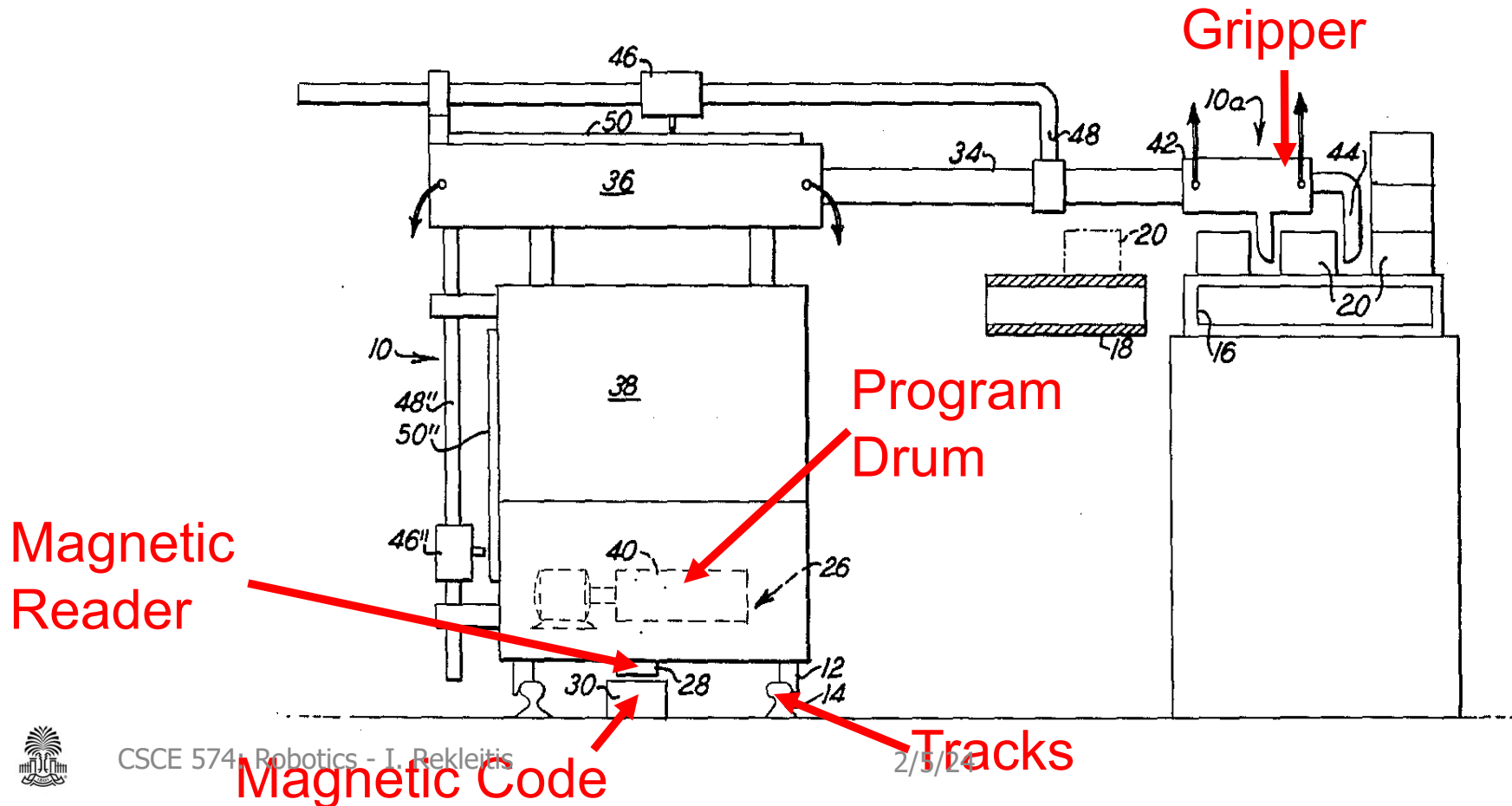

Industrial history: Unimate

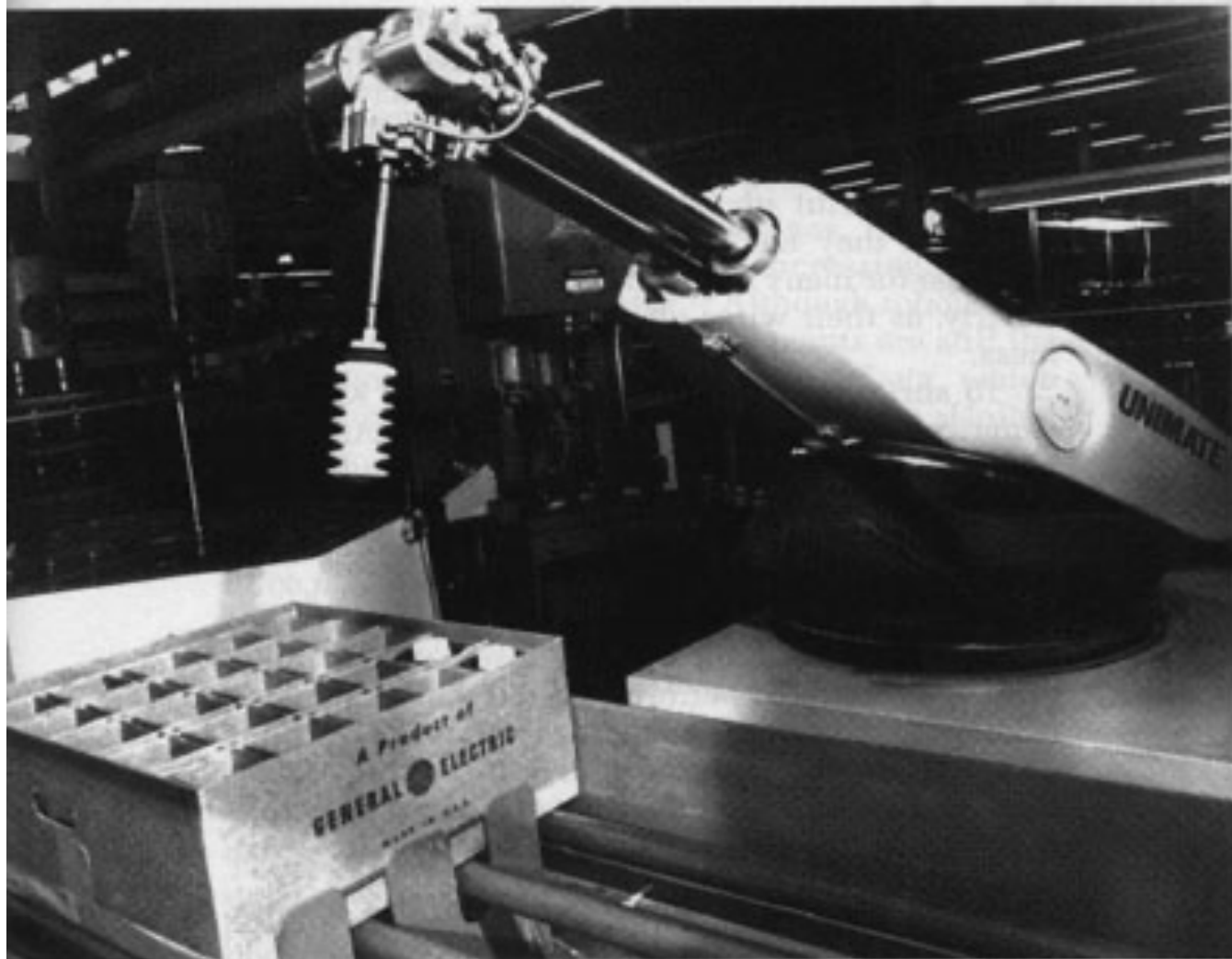

Armed for duty. A Unimate robot—really, just an arm—picks up and puts down parts in a General Electric factory.

Industrial history: Puma 1978

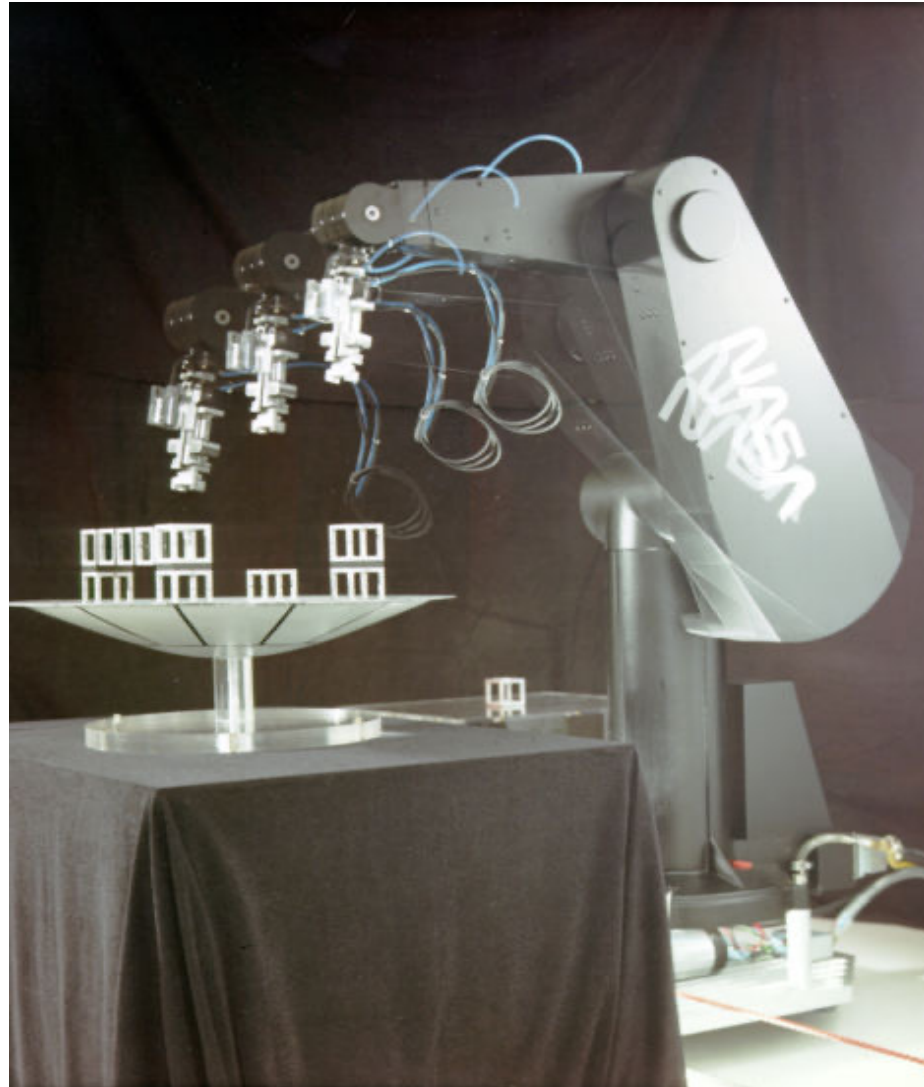

Robot Vehicle (Late 80's)

- *VaMoRs*: Highway driving
- Tracking white lines with Kalman filtering (Dickmanns)

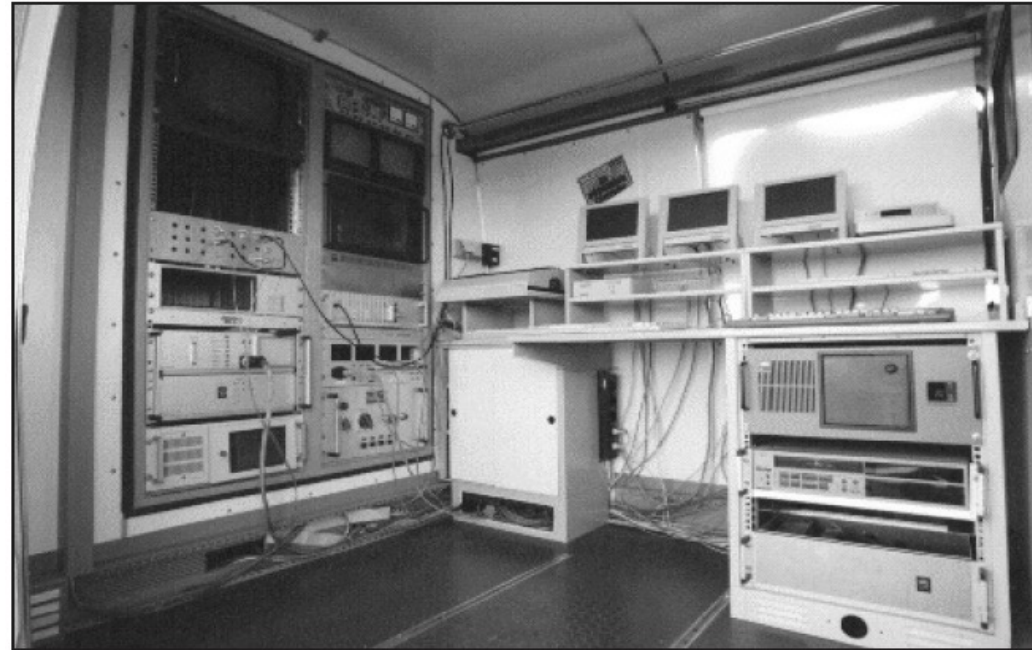

Mid 90's: CMU's Navlab 5

- Drove 2797/2849 miles (98.2%) on highways
- Throttle/Brake manually handled.



Exploring Mars

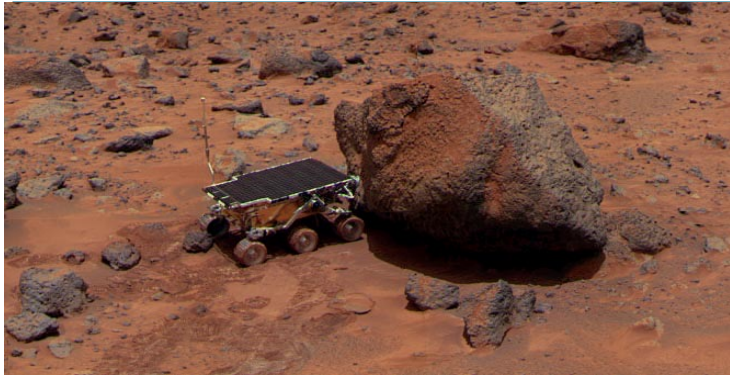

**Sojourner
1997**

**Spirit and
Opportunity
2003**

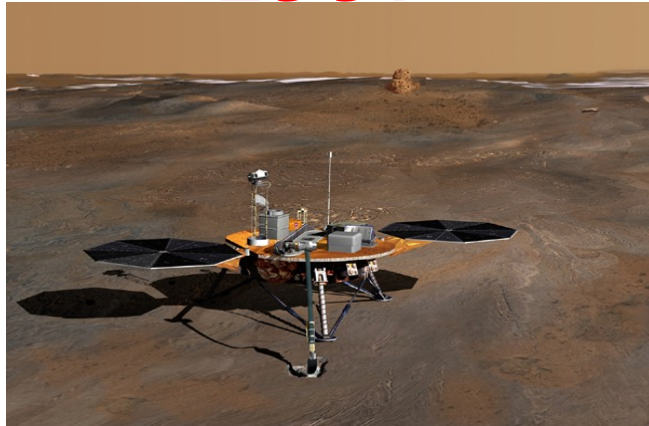

Phoenix-2008

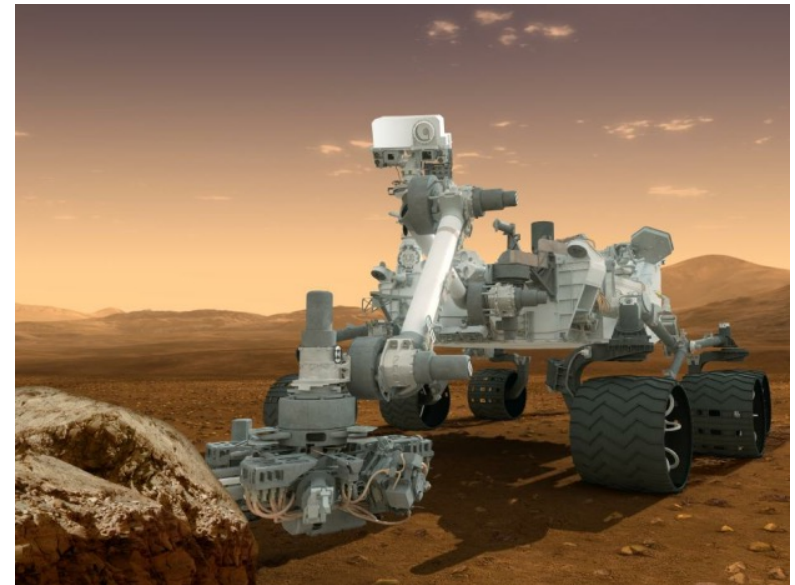

**Mars Science Laboratory
Curiosity (2012)**



More Current Data

- **Curiosity**, Sol 2155 (Aug. 29, 2018), 19.6 Km
- **Opportunity**, Sol 5111 (Jun. 10, 2018), 45.16 Km
- **Spirit**, Sol 2210 (March 22, 2010), 7.7 km

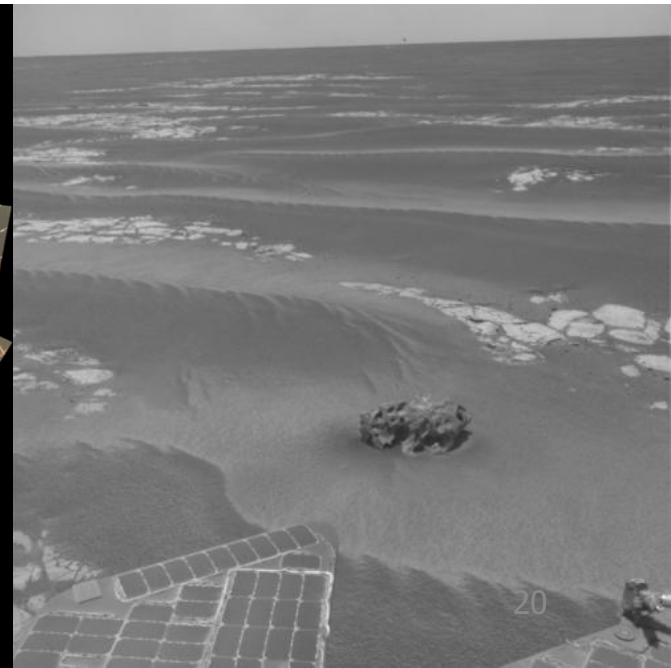
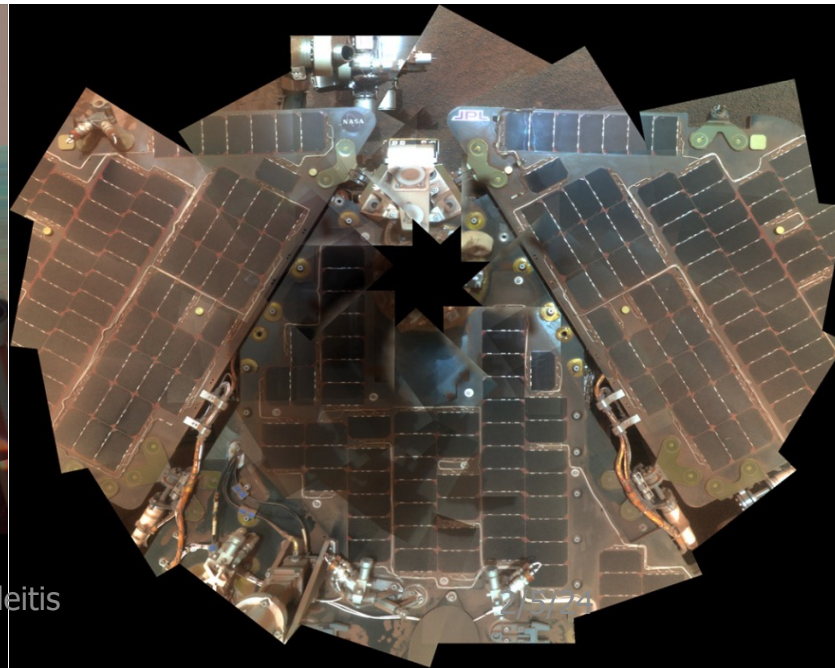
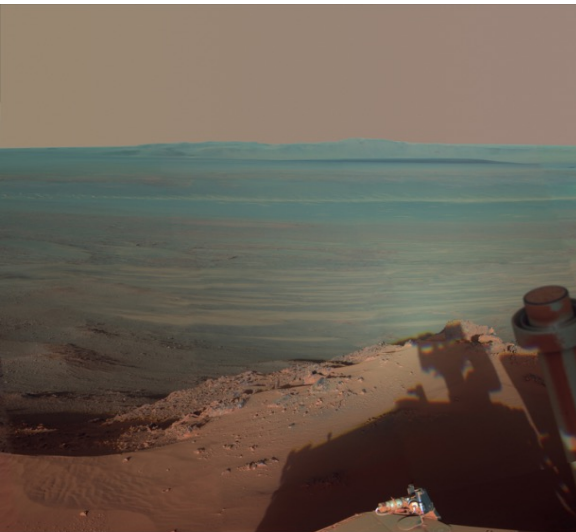

Highlights: Mapping the Titanic

Ryan Eustice, Hanumant Singh, John Leonard, Matthew Walter and Robert Ballard, *Visually navigating the RMS Titanic with SLAM information filters*. In Proceedings of the Robotics: Science & Systems Conference, pages 57-64, June 2005.

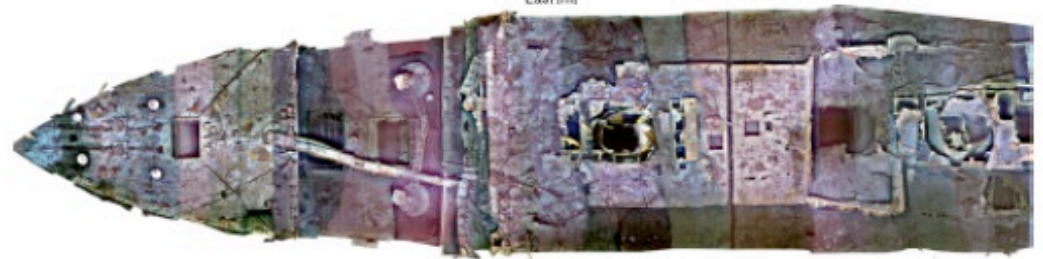
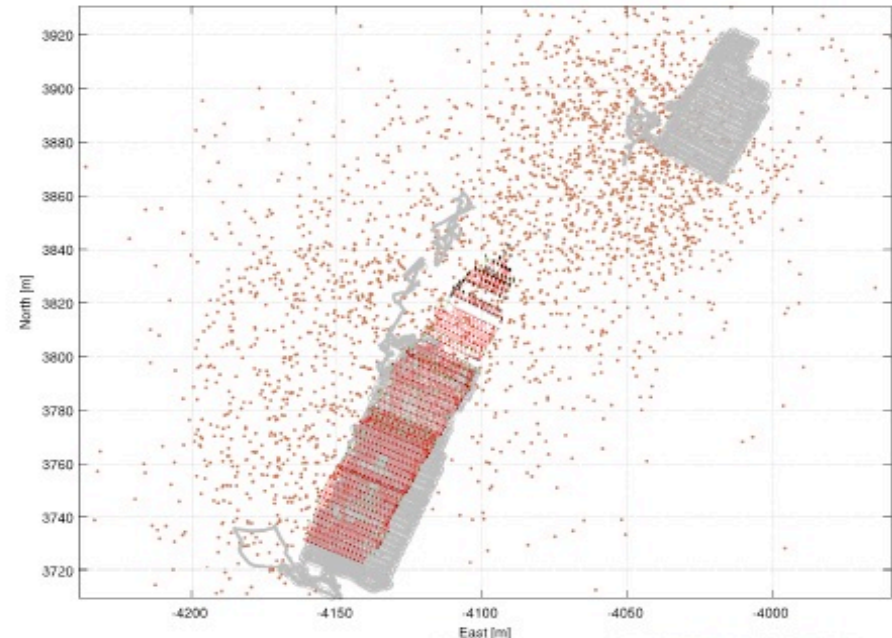

Highlights: DARPA Grand Challenge

- 2004: Mojave Desert USA, 240 km
 - CMU **Sandstorm** traveled the farthest distance, completing 11.78 km
- 2005: Mojave Desert USA, 240 km
 - Stanford's **Stanley**, first place 6h54m
 - CMU's Sandstorm, second place 7h05m



Highlights: DARPA Urban Challenge 2007

- George Air Force Base, California. 96 km urban area course



CMU's BOS,
first place 4h10m



Stanford's Junior,
second place
4h29m

Highlights: DARPA Robotics Challenge

1. Drive a utility vehicle at the site
2. Travel dismounted across rubble
3. Remove debris blocking an entryway
4. Open a door and enter a building
5. Climb an industrial ladder and traverse an industrial walkway
6. Use a tool to break through a concrete panel
7. Locate and close a valve near a leaking pipe
8. Replace a component such as a cooling pump

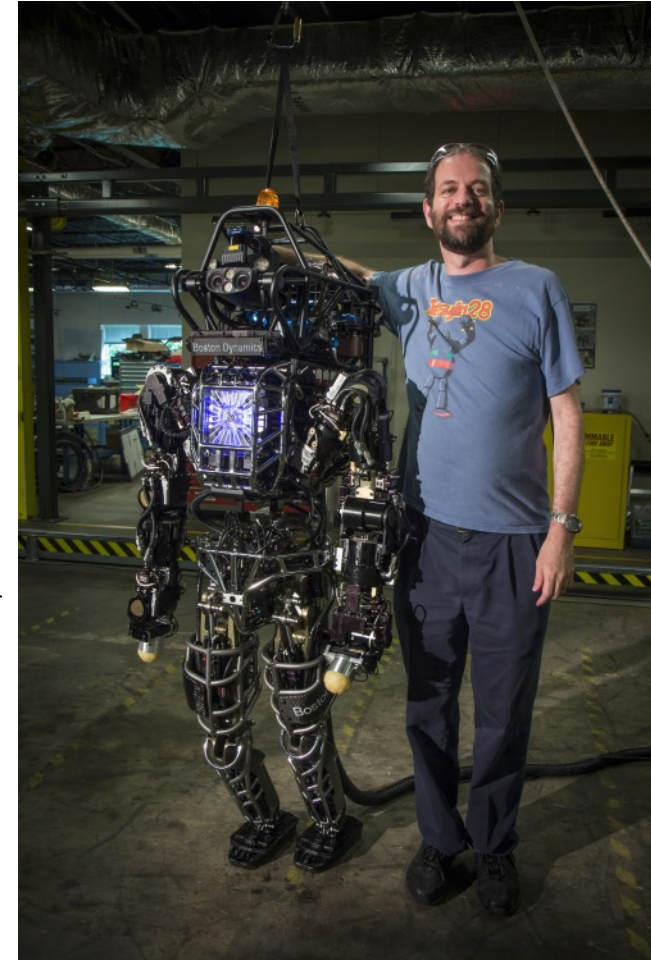

Highlights: DARPA Robotics Challenge



<http://www.youtube.com/watch?v=hpeZGCzUmNY&feature=youtu.be>



DARPA Challenge failures



<https://www.youtube.com/watch?v=g0TaYhjp0fo>



Driverless Car

- Safer
- More efficient
- Enable people



- The Nevada law went into effect on **March 1, 2012**, and the Nevada Department of Motor Vehicles issued the first license for a self-driven car in **May 2012**. The license was issued to a Toyota Prius modified with Google's experimental driverless technology.
- Google driverless car, with a test fleet of autonomous vehicles that as of Aug. 2018 has driven **12.8 million** km.



Another trend

Mobile Manipulation

The robots have only interpreted the world, in various ways; the point is to change it.

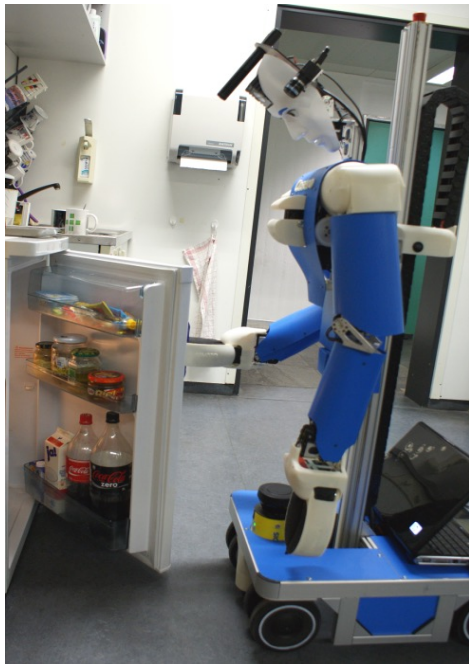

<http://pr.cs.cornell.edu/videos.php>

