



UNIVERSITY OF
SOUTH CAROLINA

CSCE 574 ROBOTICS

Exploration



Grid Based Maps

- Occupied cells
- Free cells
- Unknown cells

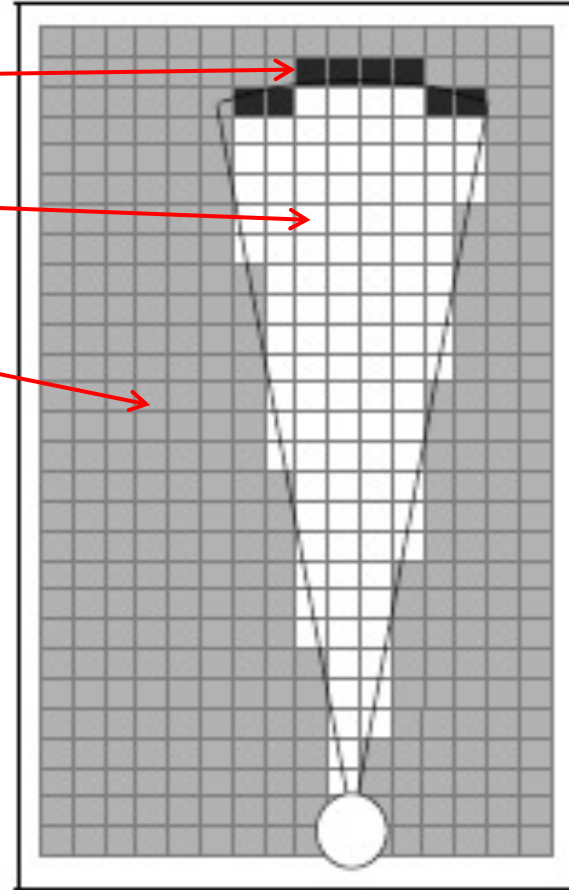

Frontier based Exploration (Grid Maps)

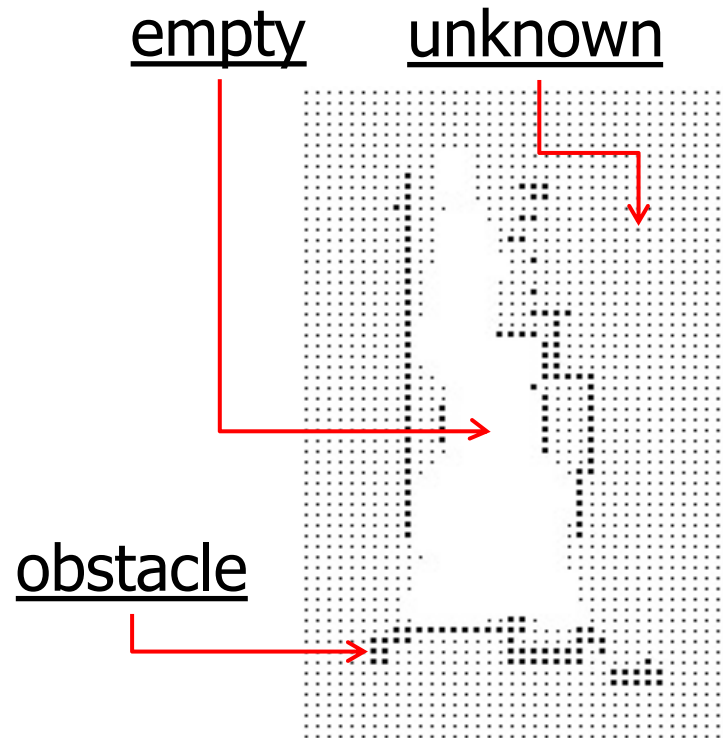

Frontier
Cells



Frontier
Targets

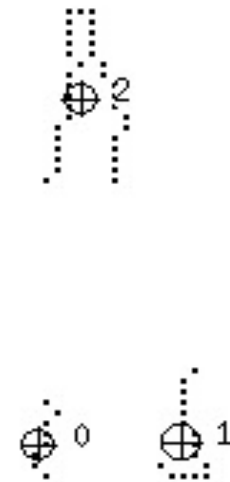

Topological Representations

- Apply on a topological map

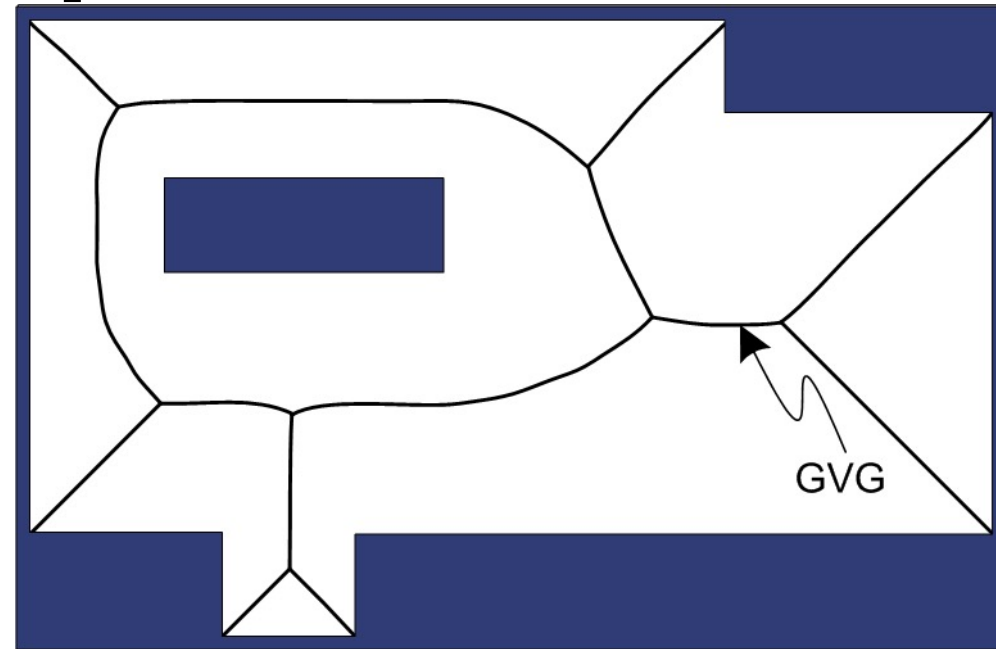
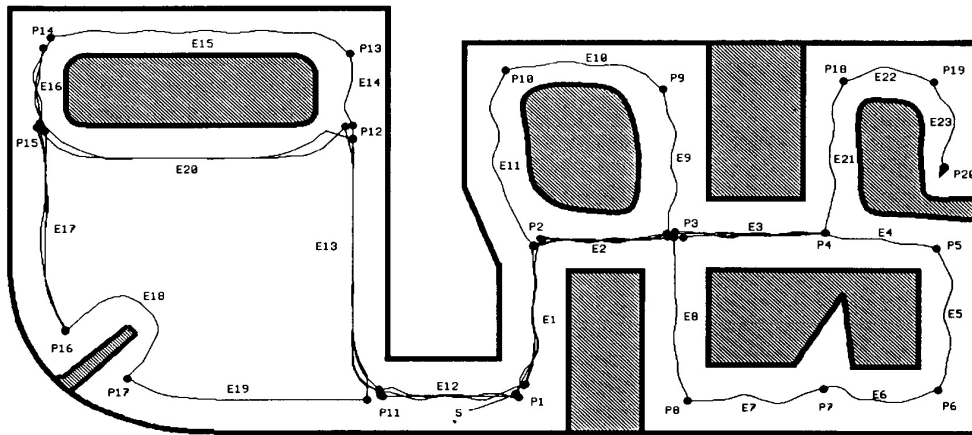

- B. J. Kuipers and Y.-T. Byun. “A robot exploration and mapping strategy based on a semantic hierarchy of spatial representations”. In *Journal of Robotics and Autonomous Systems*, 8: 47-63, 1991.

H. Choset, J. Burdick, “Sensor based planning, part ii: Incremental construction of the generalized Voronoi graph”. In *IEEE Conference on Robotics and Automation*, pp. 1643 – 1648, 1995.



Generalized Voronoi Graph (GVG)

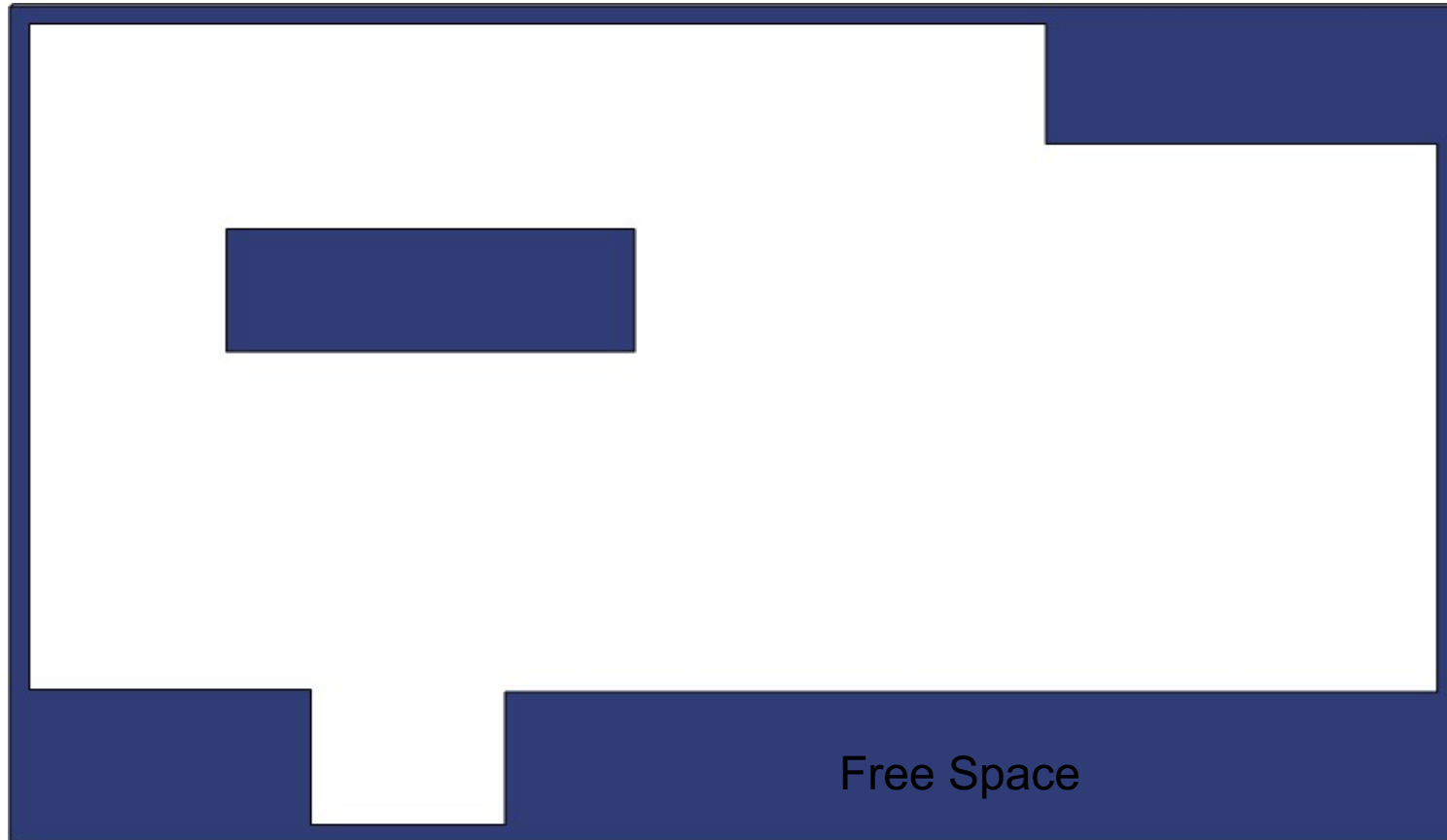

H. Choset, J. Burdick, “Sensor based planning, part ii: Incremental construction of the generalized voronoi graph”. In IEEE Conference on Robotics and Automation, pp. 1643 – 1648, 1995.



Generalized Voronoi Graph (GVG)

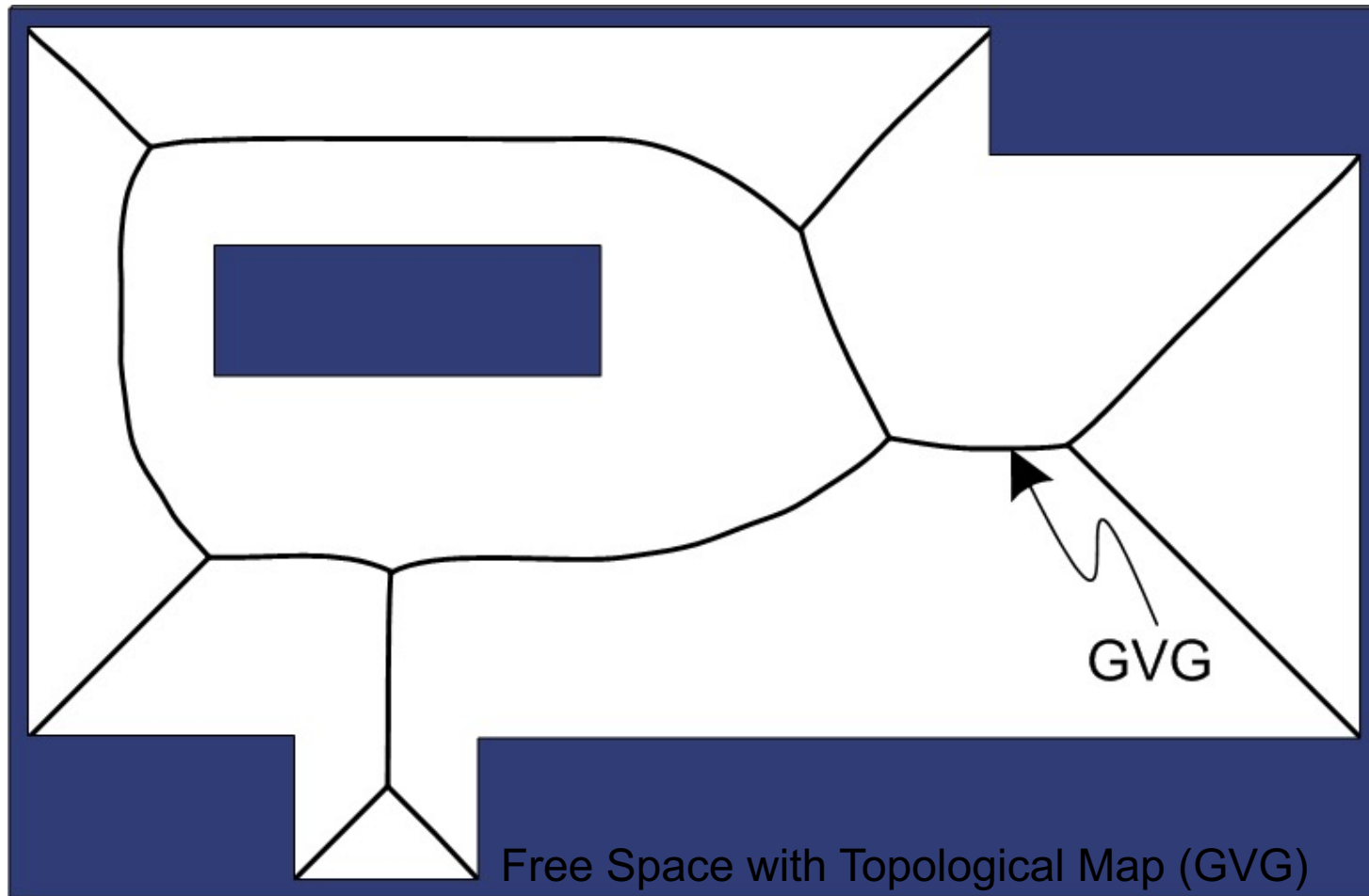

Generalized Voronoi Graph (GVG)

- Access GVG

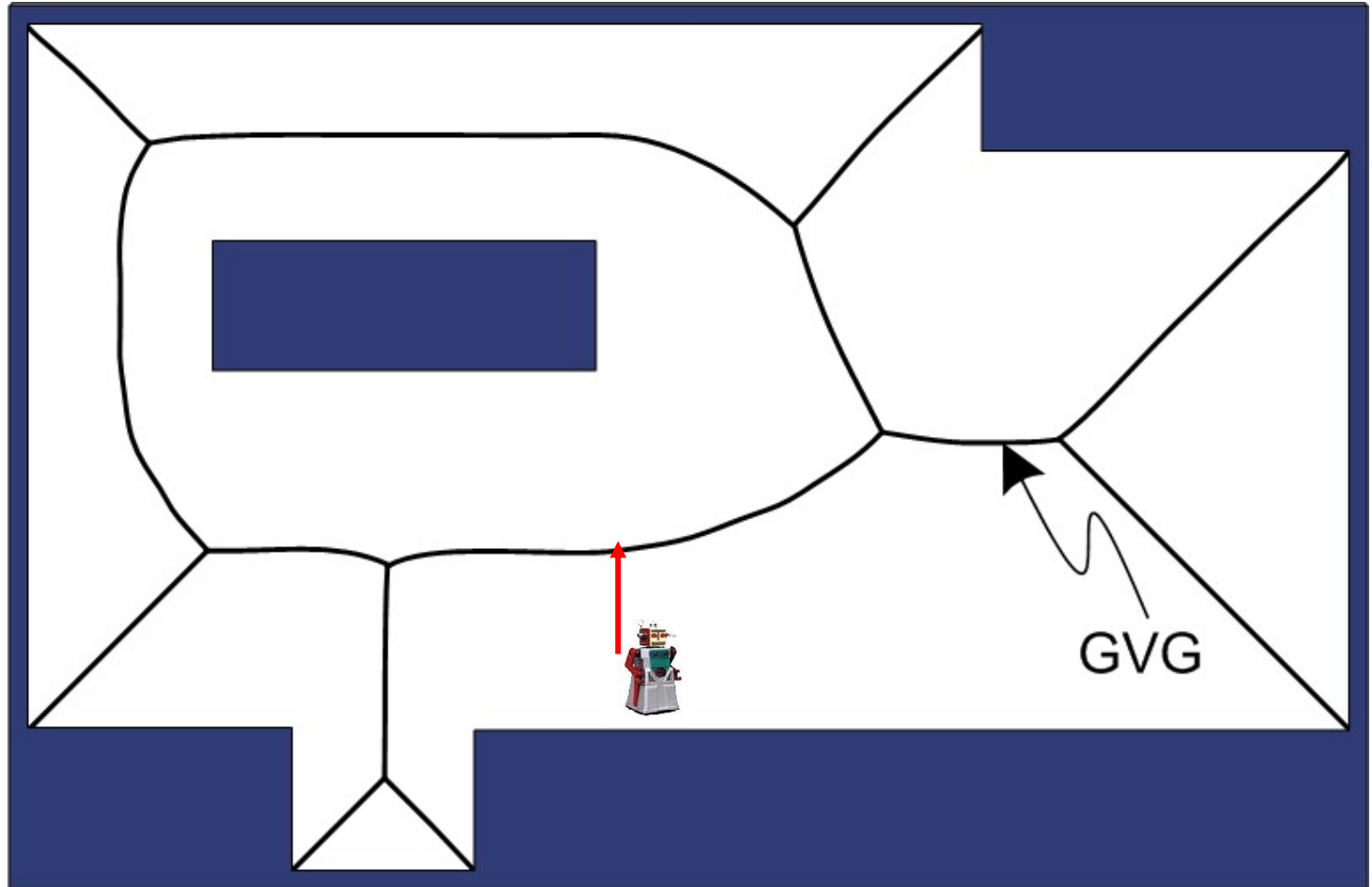

Free Space with Topological Map (GVG)

Generalized Voronoi Graph (GVG)

- Access GVG
- Follow Edge
- Home to the MeetPoint
- Select Edge

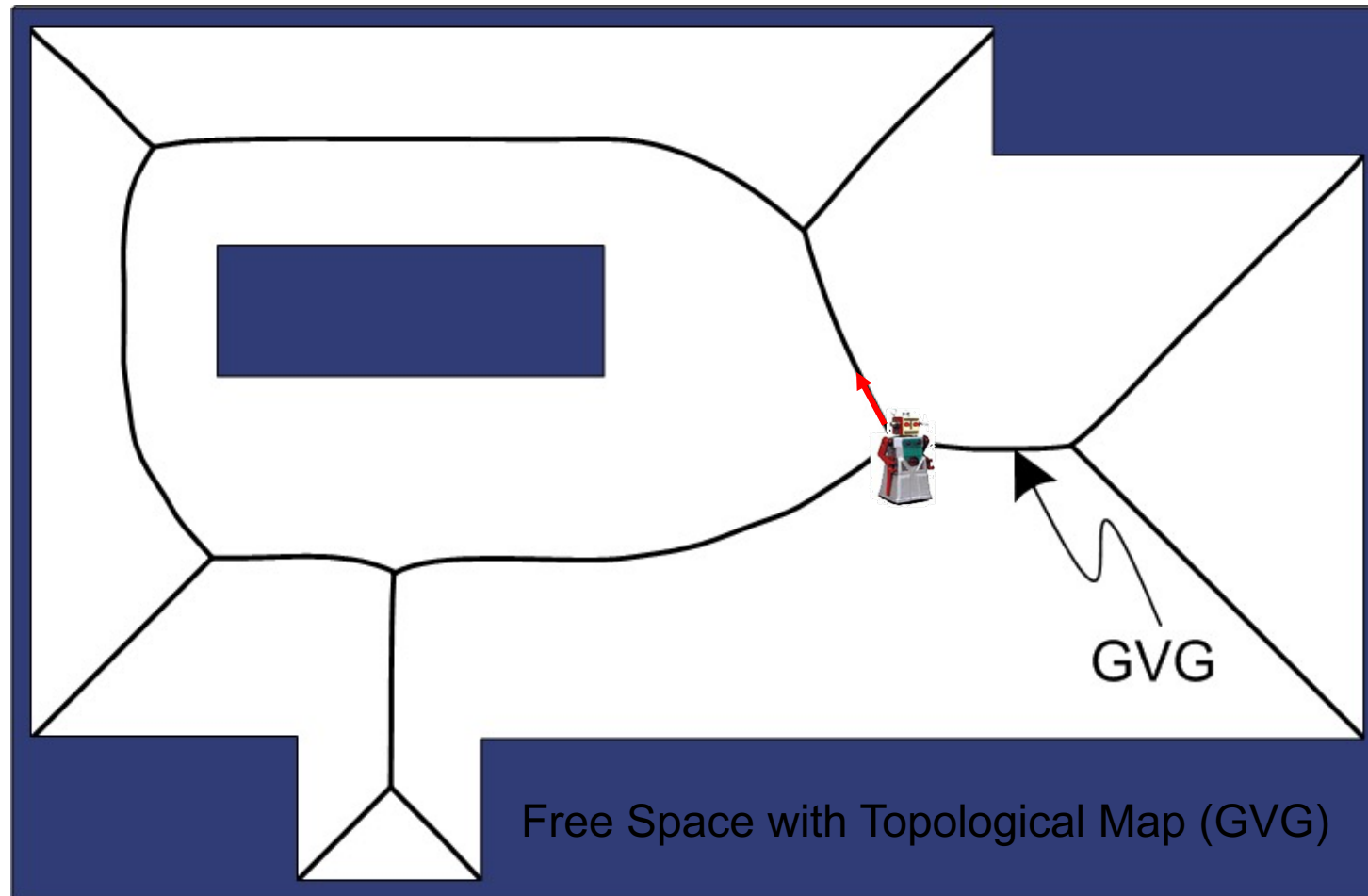



Cooperative Exploration

- **Robot Position:**
 - Stationary Robot: Positioned at the corners of the environment
 - Moving Robot: Follows the walls.
- **Exploration order:**
 - The two robots explore the free space by following the Dual Graph of the Triangulation.
- **Decision points:**
 - Reflex vertices.

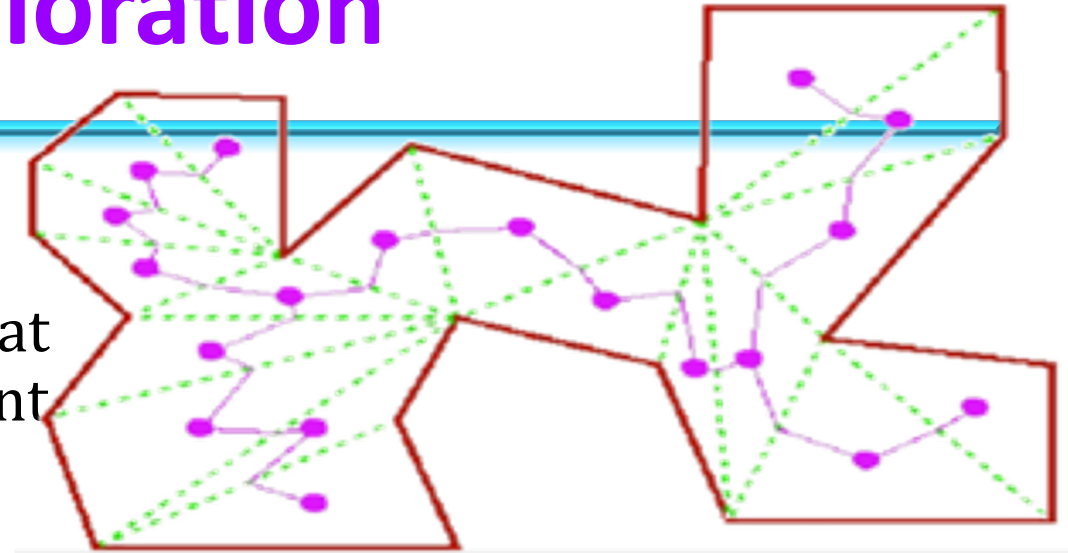

Irregular Triangular Mesh (ITM)

- Terrain Representation
- Underlying Topological Structure
- Path Planning and Exploration

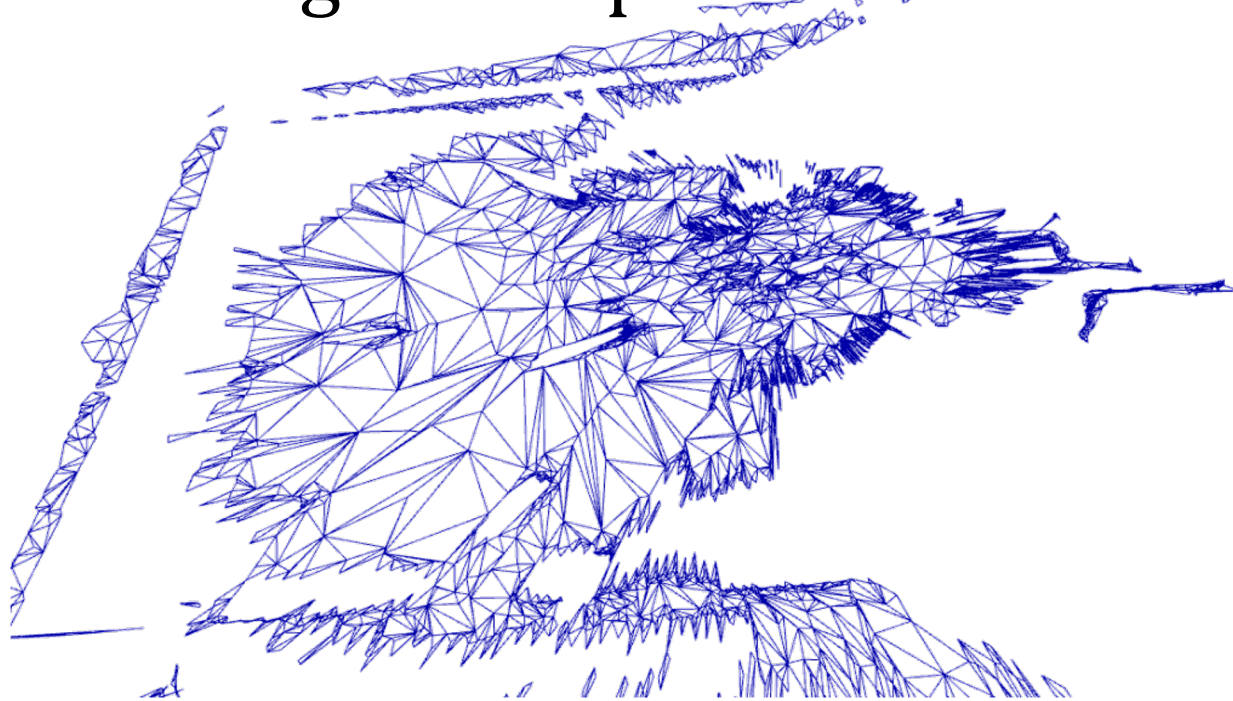

From 2.5D Representation to Topological

- Convert ITM into Connected Graph

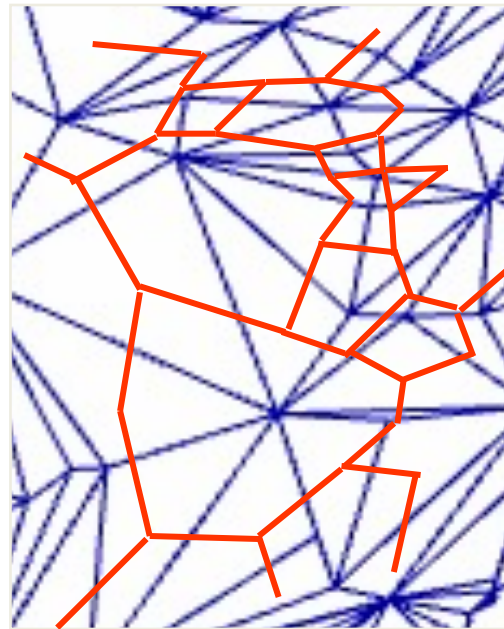

Planning

- Convert ITM into Connected Graph
- Planning using Graph Search Algorithms:
 - Dijkstra, A* search algorithms

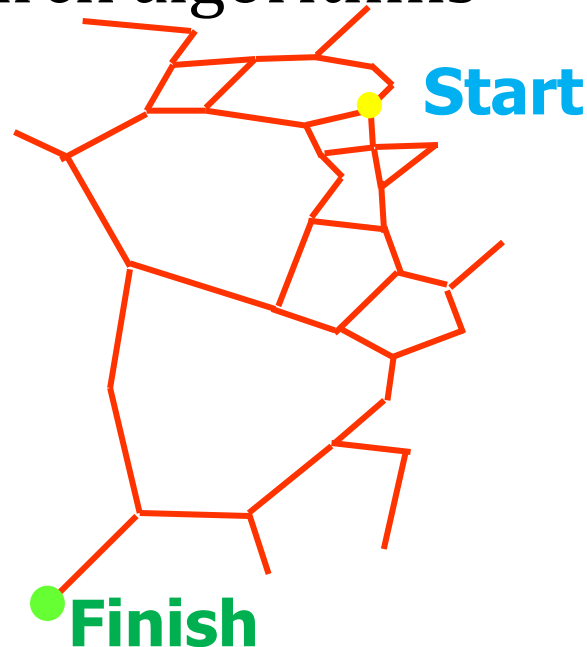

Planning

- Convert ITM into Connected Graph
- Path Planning using Graph Search Algorithms:
 - Dijkstra, A* search algorithms
- Different Cost Functions Q
 - Number of triangles $Q = 1$

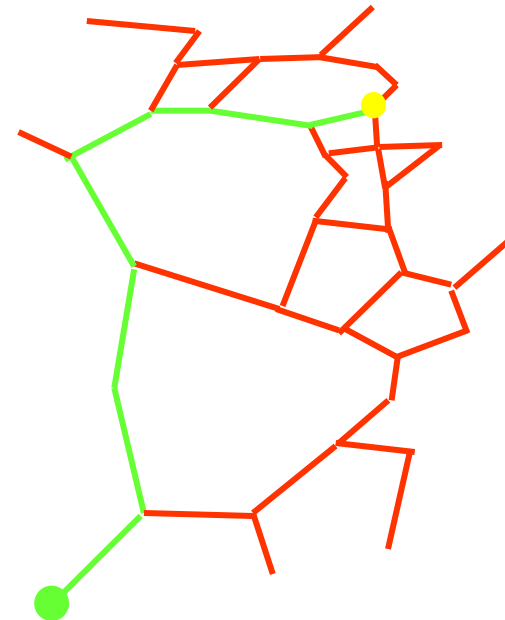

Planning

- Convert ITM into Connected Graph
- Path Planning using Graph Search Algorithms:
 - Dijkstra, A*
- Different Cost Functions Q
 - Number of triangles
 - Euclidian distance $Q = \|\vec{x}_i - \vec{x}_j\|$

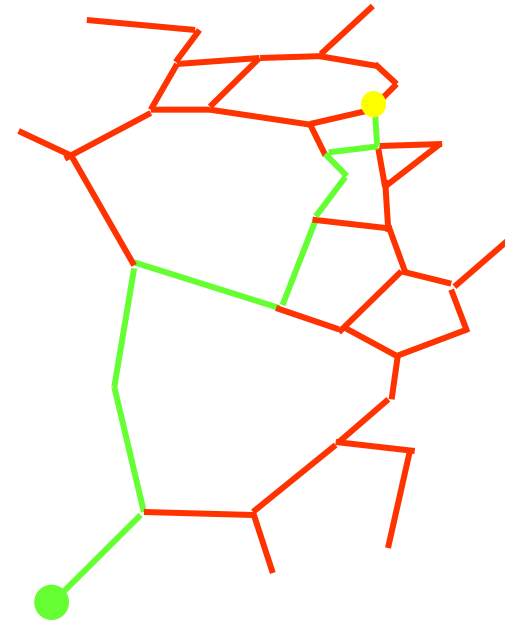

Planning

- Convert ITM into Connected Graph
- Path Planning using Graph Search Algorithms:
 - Dijkstra, A*
- Different Cost Functions Q
 - Number of triangles
 - Euclidian distance
 - Slope of each triangle

$$v_j = \frac{p_j^1 \times p_j^2}{\|p_j^1\| \|p_j^2\|}$$

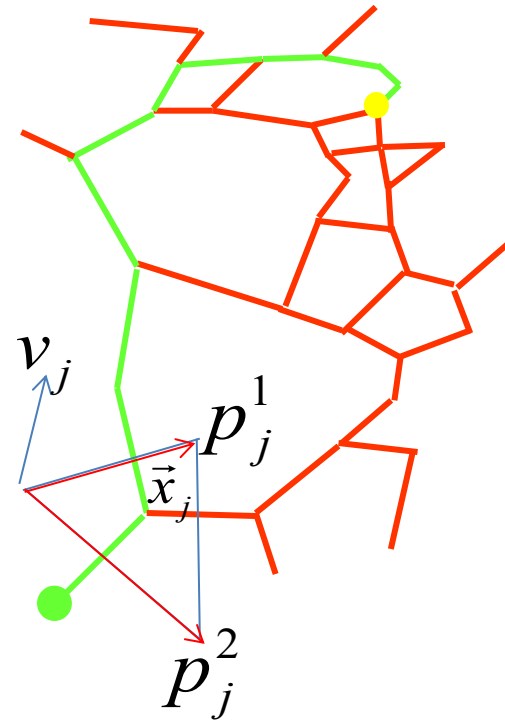

Planning

- Convert ITM into Connected Graph
- Path Planning using Graph Search Algorithms:
 - Dijkstra, A*
- Different Cost Functions Q
 - Number of triangles
 - Euclidian distance
 - Slope of each triangle
 - Cross triangle slope

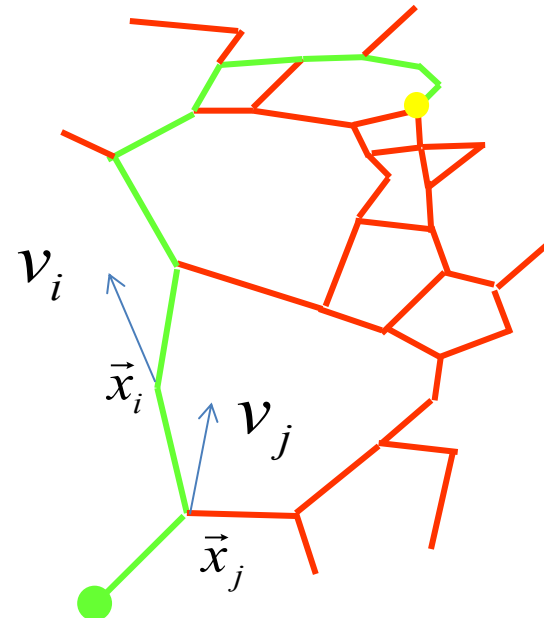

Exploration via Graph Search

- Exhaustive Depth First Search
- Breadth-First Search
- Heuristics



Exploring a Camera Sensor Network

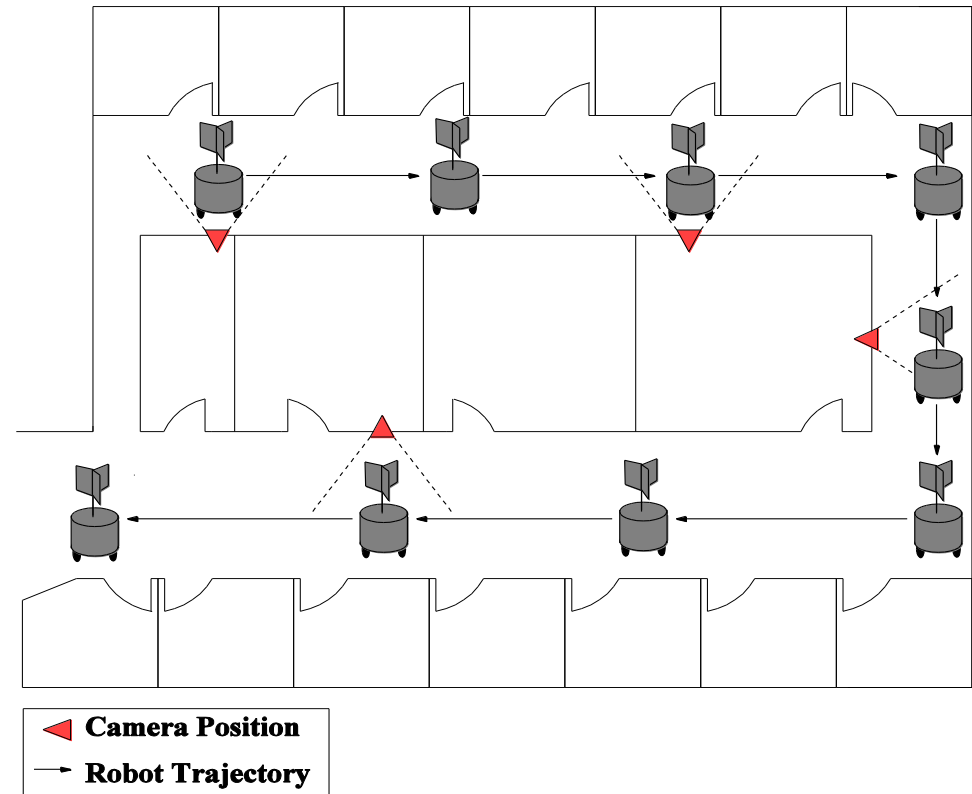
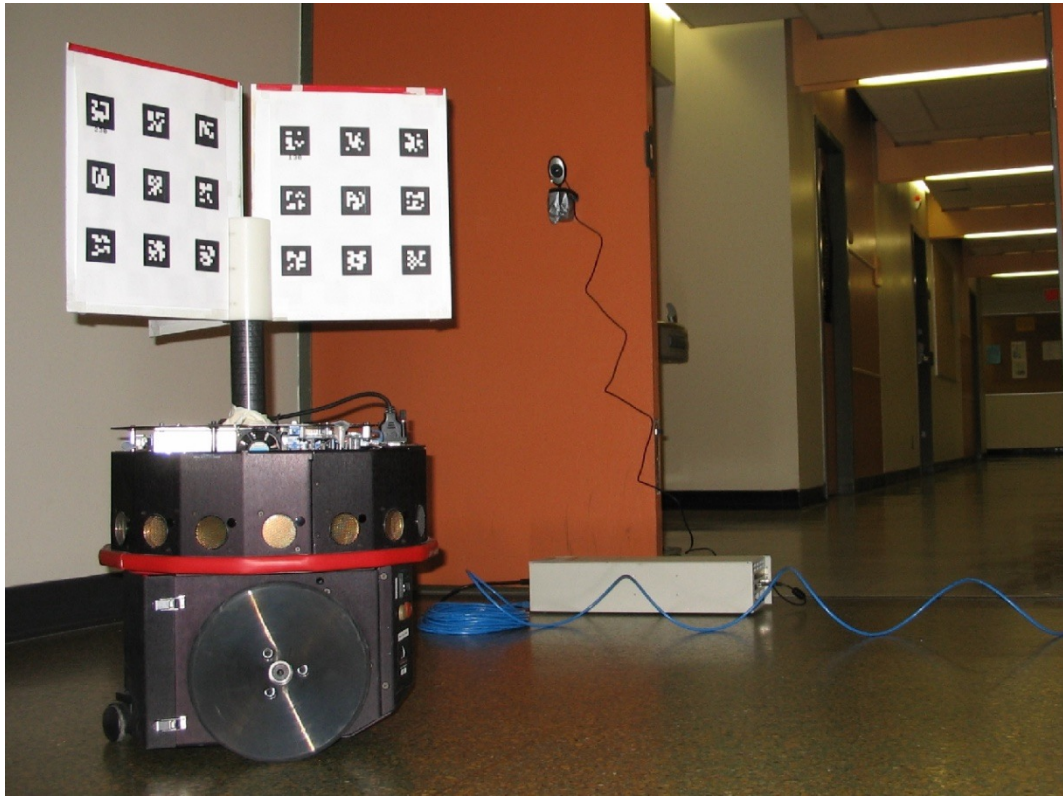

D. Meger, I. Rekleitis, and G. Dudek. "Heuristic Search Planning to Reduce Exploration Uncertainty", IROS 2008.



Exploration Planning Problem

Two fundamental problems for path planning during exploration and mapping:

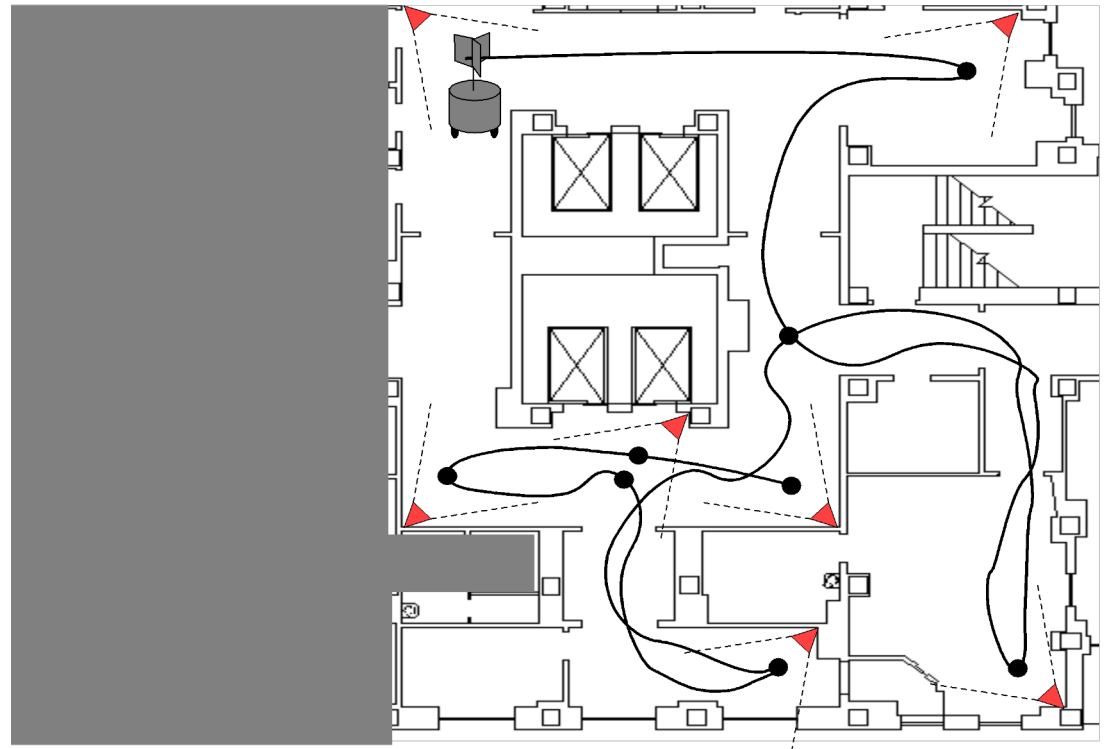

Exploration Planning Problem

Two fundamental problems for path planning during exploration and mapping:

- Planning for re-localization
- Planning the exploration of new territory

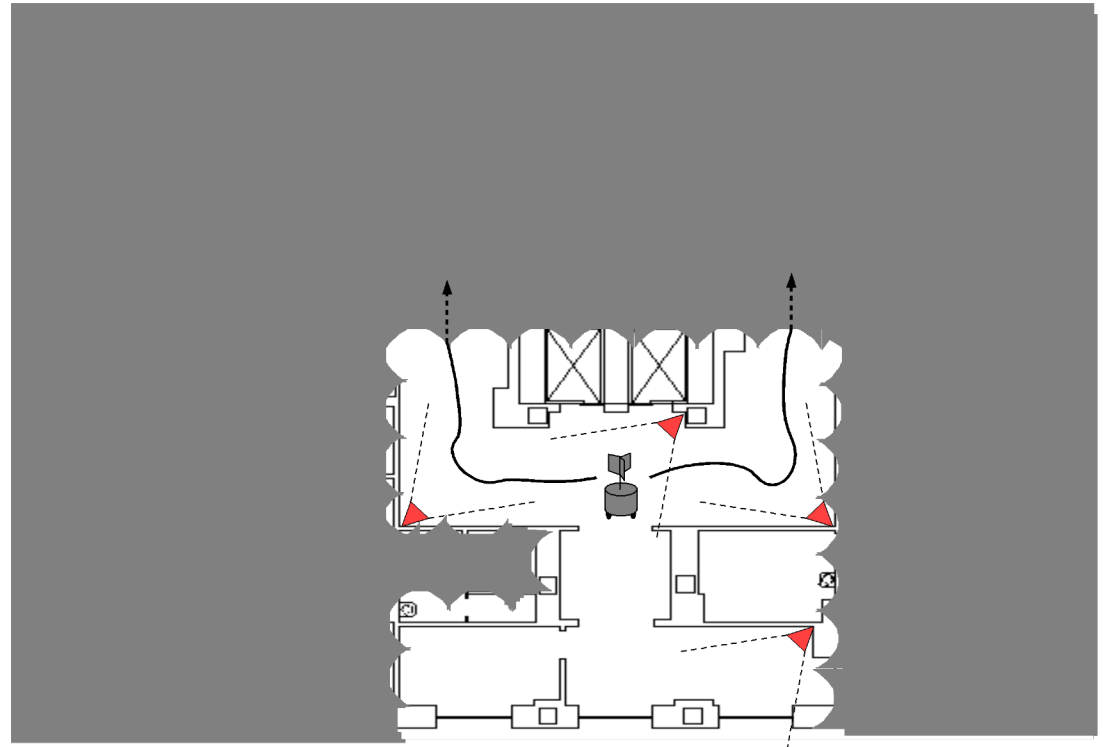

Heuristic Search Planning Method

- Solution to exploration planning for camera sensor networks
 - Composed of two alternated steps: exploration and re-localization
 - Combined distance and uncertainty cost function
 - Heuristic search for good paths



Exploration and Uncertainty Reduction

- Decision (exploration vs exploitation)
- Target Node
- Path Planning through the known graph
- Exploration Strategies



Exploration and Uncertainty Reduction

- Decision (exploration vs. exploitation)
 - **Epsilon-Greedy**
 - **Epsilon-First**
 - **Adaptive**
 - **Bounded Uncertainty**
- Target Node
- Path Planning through the known graph
- Exploration Strategies



Exploration and Uncertainty Reduction

- Decision (exploration vs. exploitation)
- Target Node (Exploration)
 - **Random**
 - **Shortest distance**
 - **Maximum Uncertainty**
 - **Minimum Uncertainty**
- Path Planning through the known graph
- Exploration Strategies



Exploration and Uncertainty Reduction

- Decision (exploration vs. exploitation)
- Target Node (Relocalization)
 - **Maximum Uncertainty**
- Path Planning through the known graph
- Exploration Strategies



Exploration and Uncertainty Reduction

- Decision (exploration vs. exploitation)
- Target Node
- Path Planning through the known graph
 - Work with D. Meger and G. Dudek [IROS 2008]
 - A* based strategy
 - Cost: $C(p) = \omega_d \text{length}(p) + \omega_u \text{trace}(P(p))$
 - Distance-based “cost-to-go” heuristic function h used to compute estimated cost

$$C(n) = f(n) + h(n)$$

Estimated cost through n

Cost so far

Estimated cost to go

- Exploration Strategies



Effect of α Parameter for Relocalization

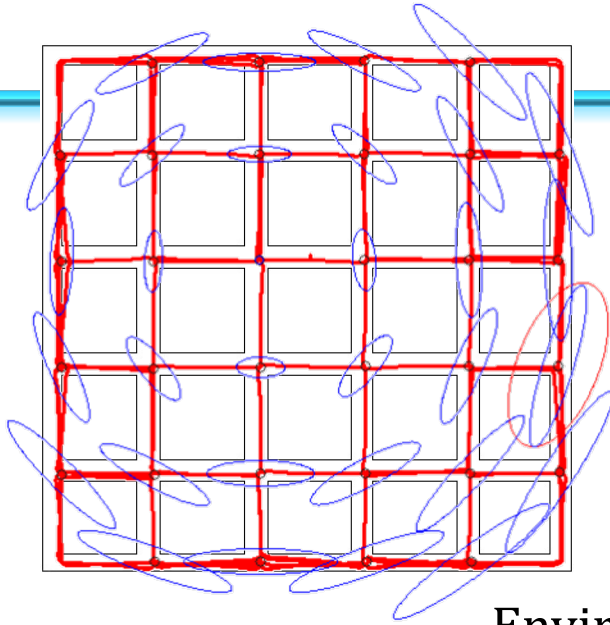

Environment with map

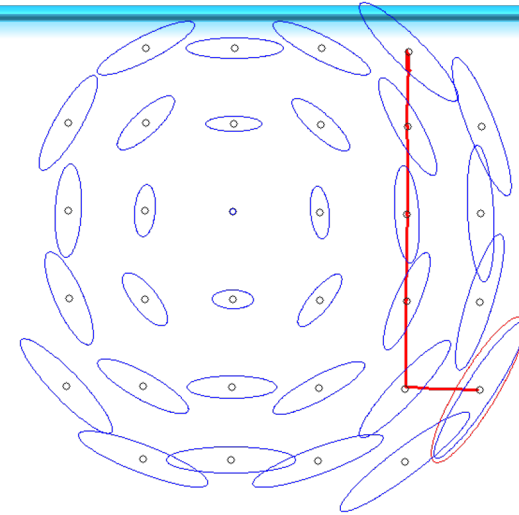

Shortest Path ($\alpha=1$)

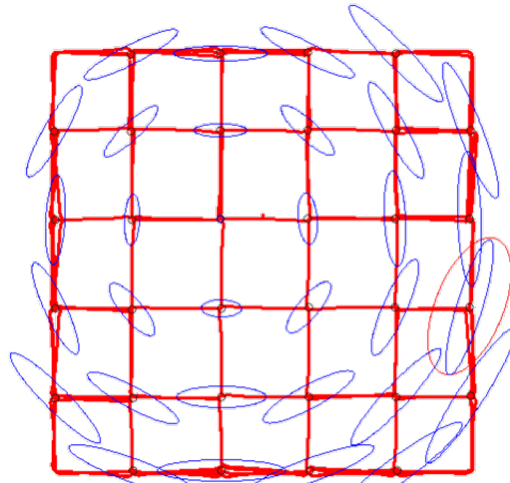

Initial map

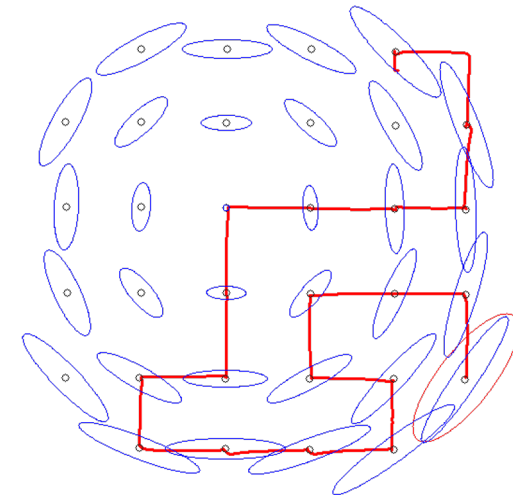

Lower Uncertainty ($\alpha=0$)



Effect of α Parameter for Relocalization

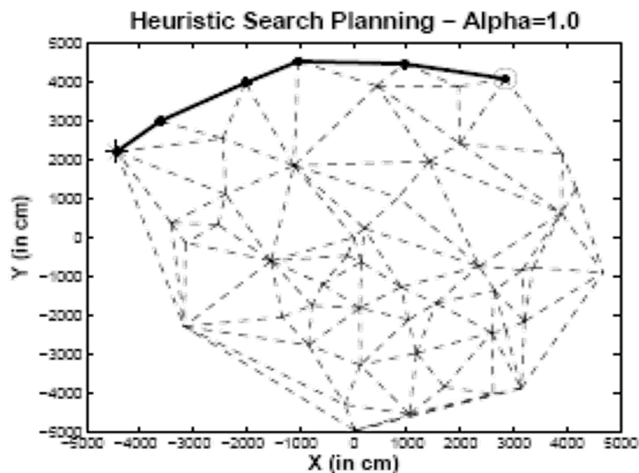

(a)

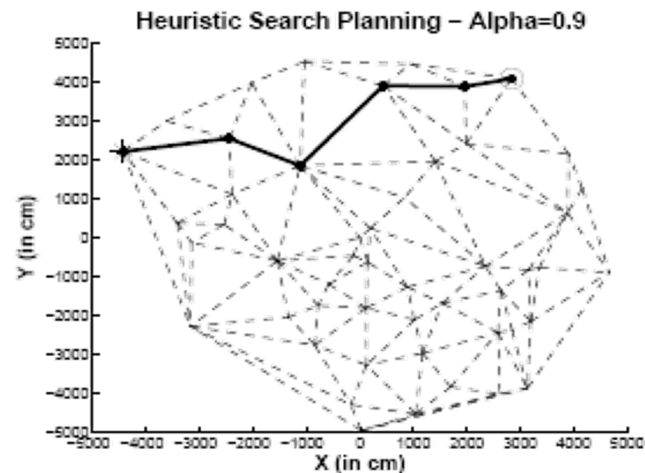

(b)

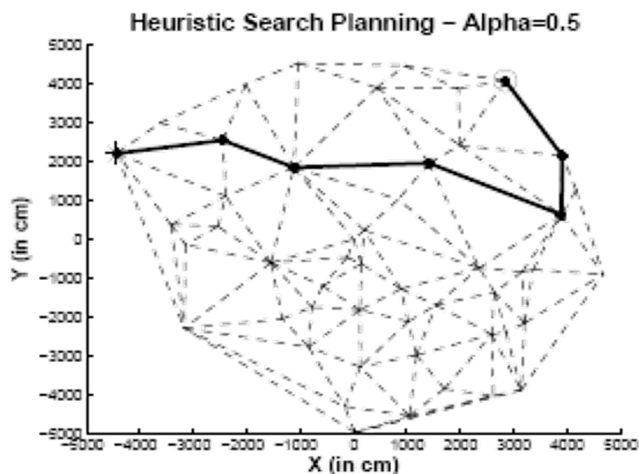

(c)

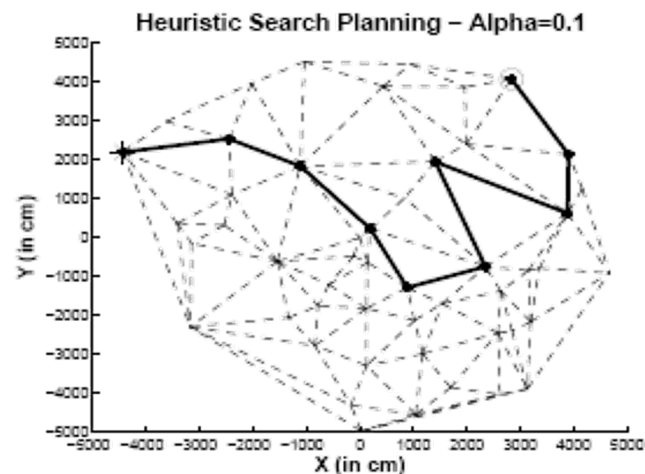

(d)



Exploration and Uncertainty Reduction

- Decision (exploration vs. exploitation)
- Target Node
- Path Planning through the known graph
- **Exploration Strategies**
 - One Step Exploration
 - Ear based exploration



Shortest Node

$P(\text{exploit})=0.3$

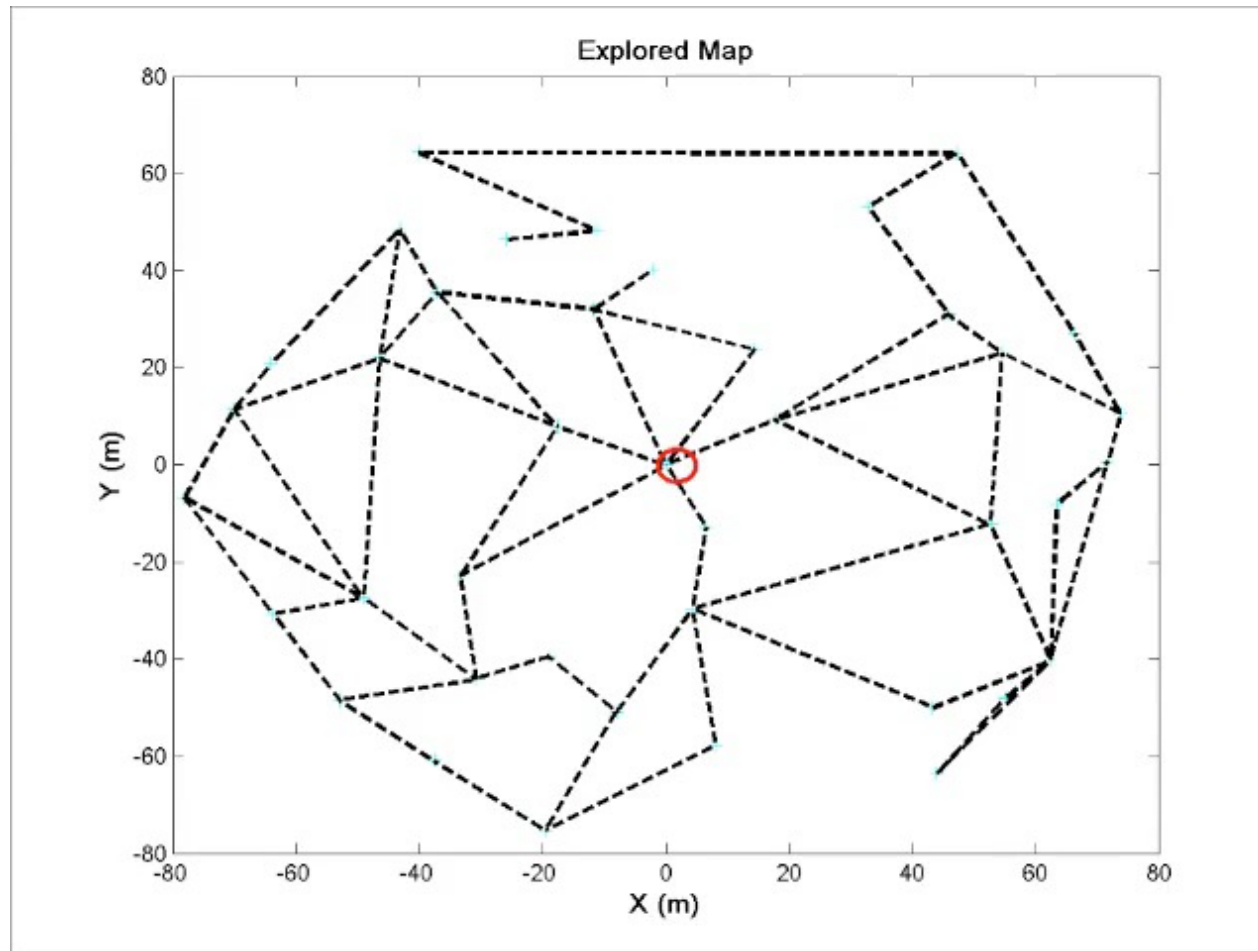

Experimental Results

Bounded Uncertainty

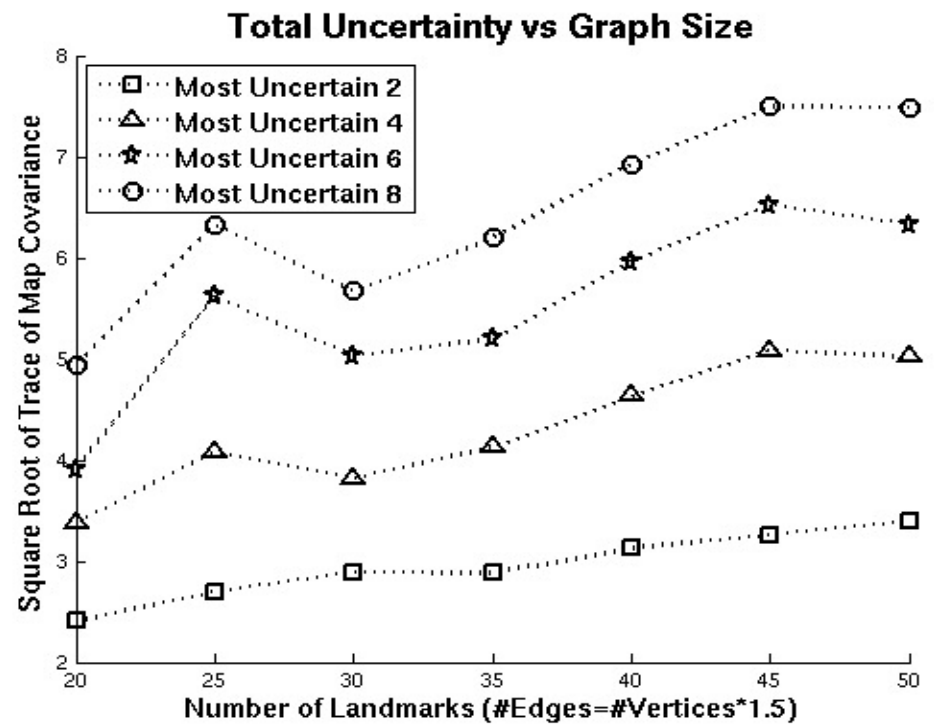
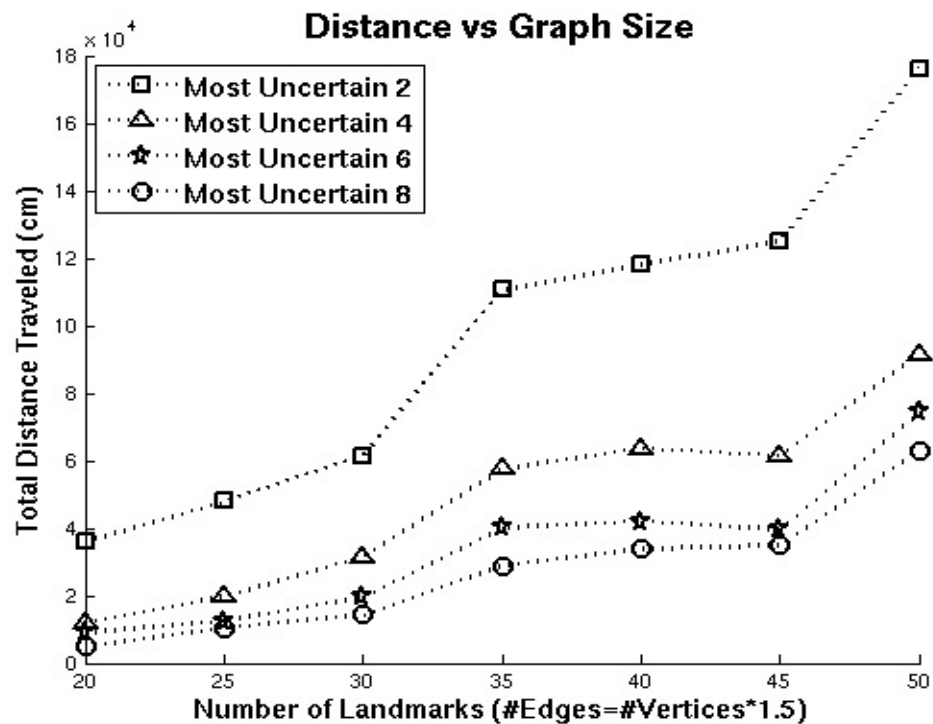

Experimental Results

Different Strategies

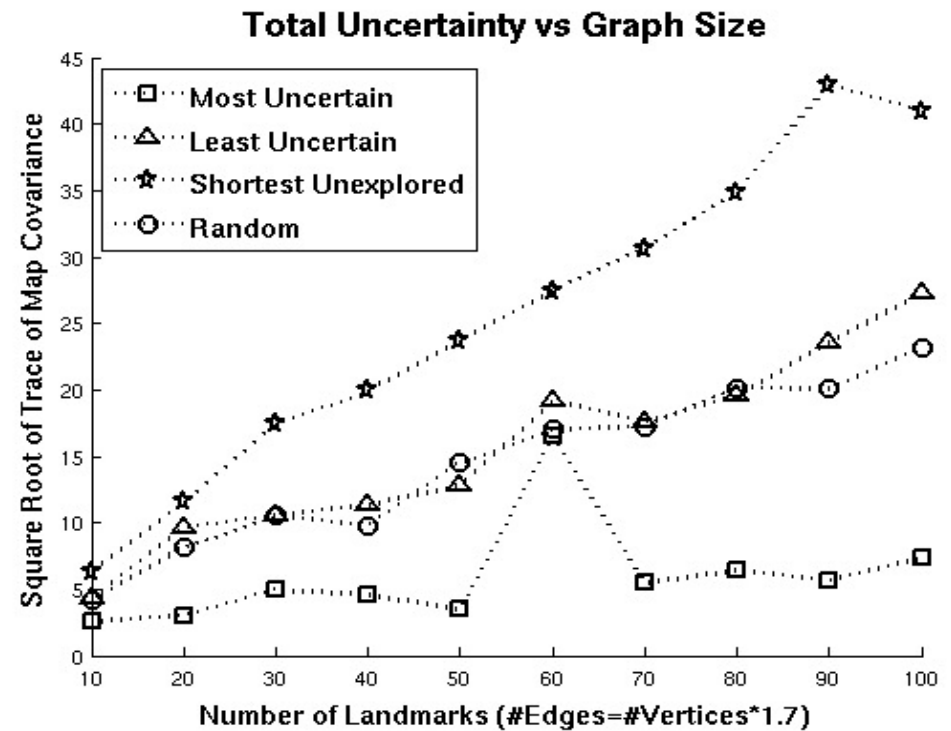
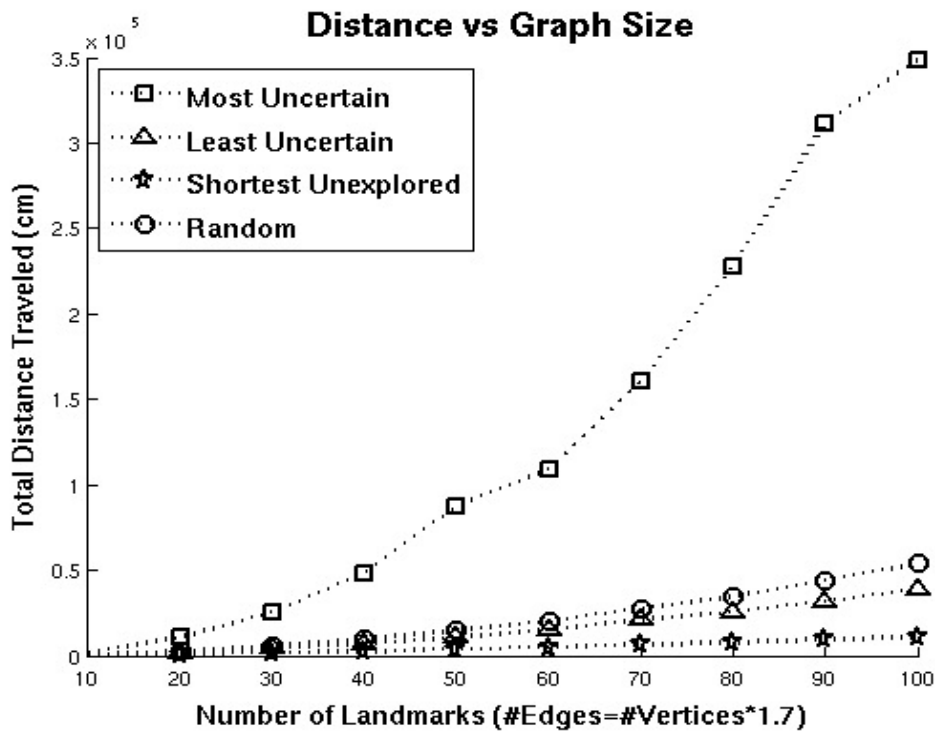

Planning Exploratory Steps

- Choose motion in unexplored space to locate additional camera nodes
- Planner cannot simulate these paths
- Evaluated 2 strategies: 1) nearest camera and 2) a randomly selected camera

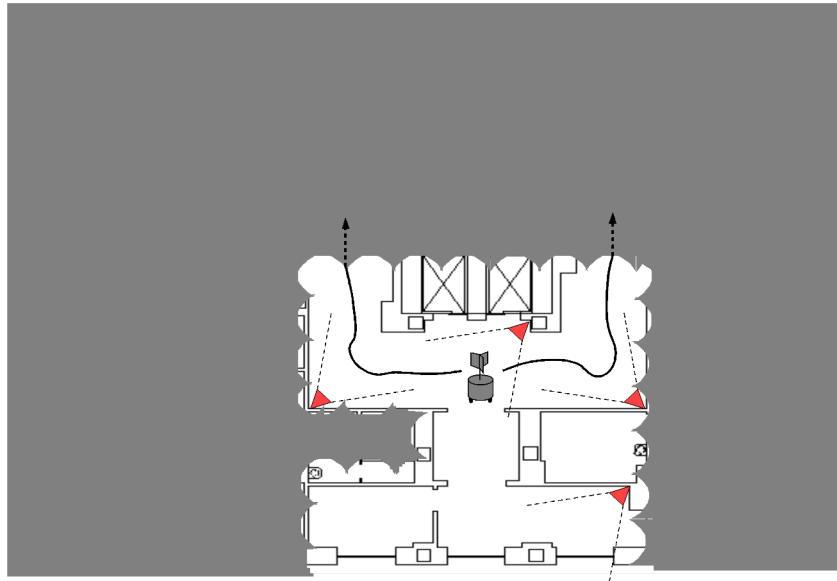

Simulation Results

- Compared planners over many trials
- 3 realistic network types (2 shown)
- 3 methods for comparison:
 - Depth-first
 - Return to origin
 - Return to nearest explored

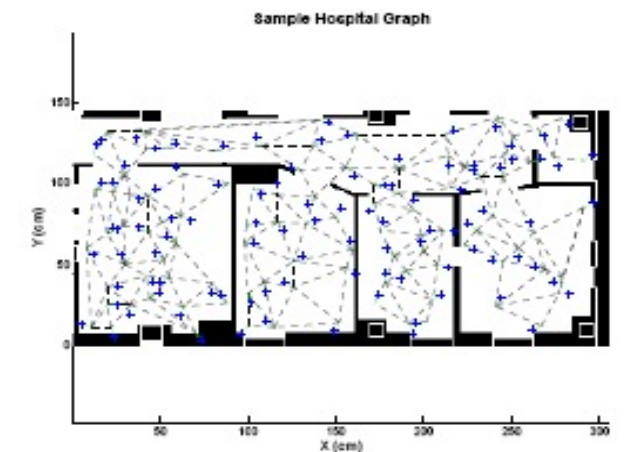
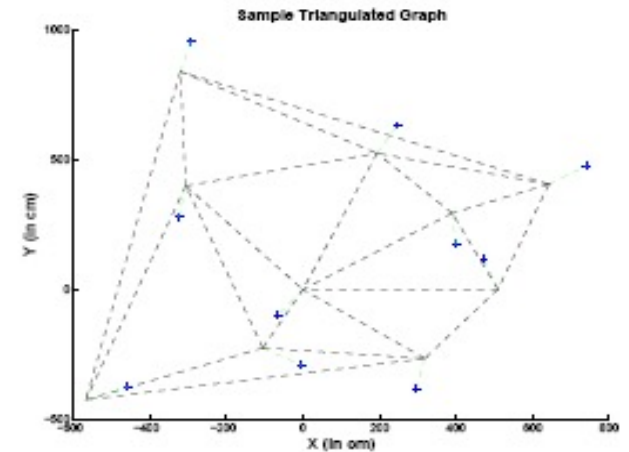

Simulated Relocalization Results

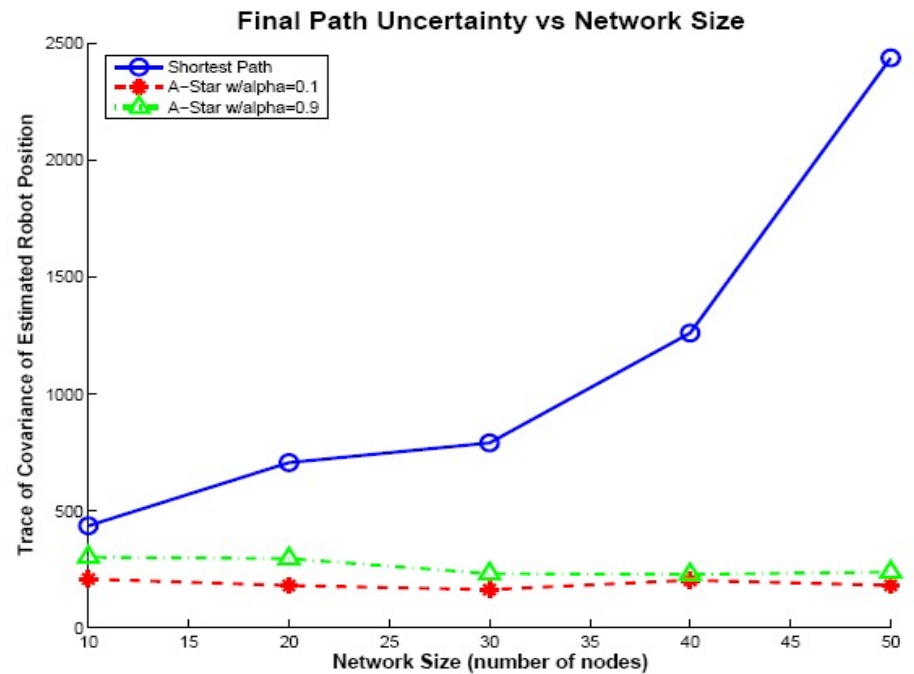
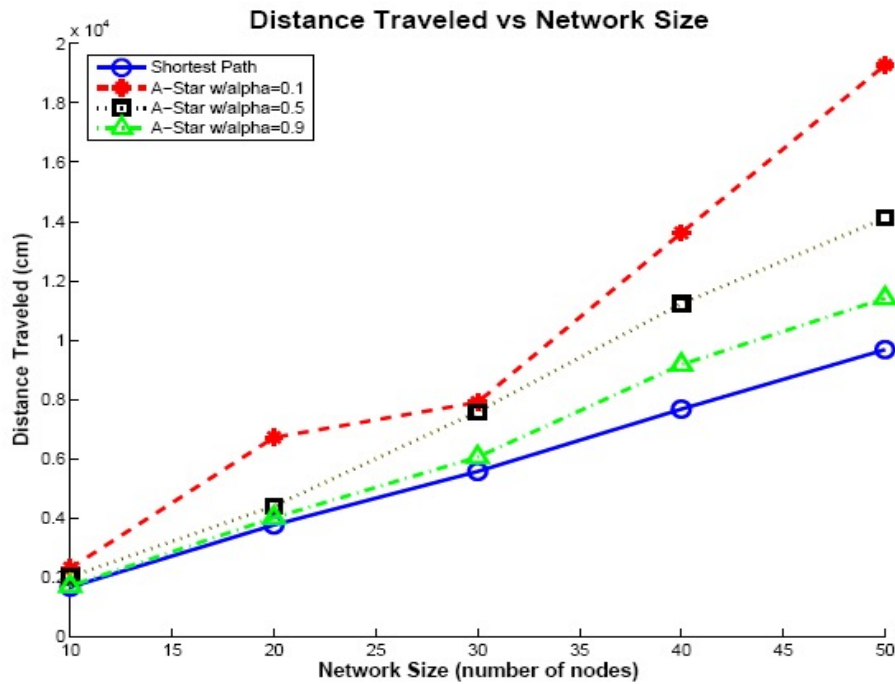

Simulated Exploration Results

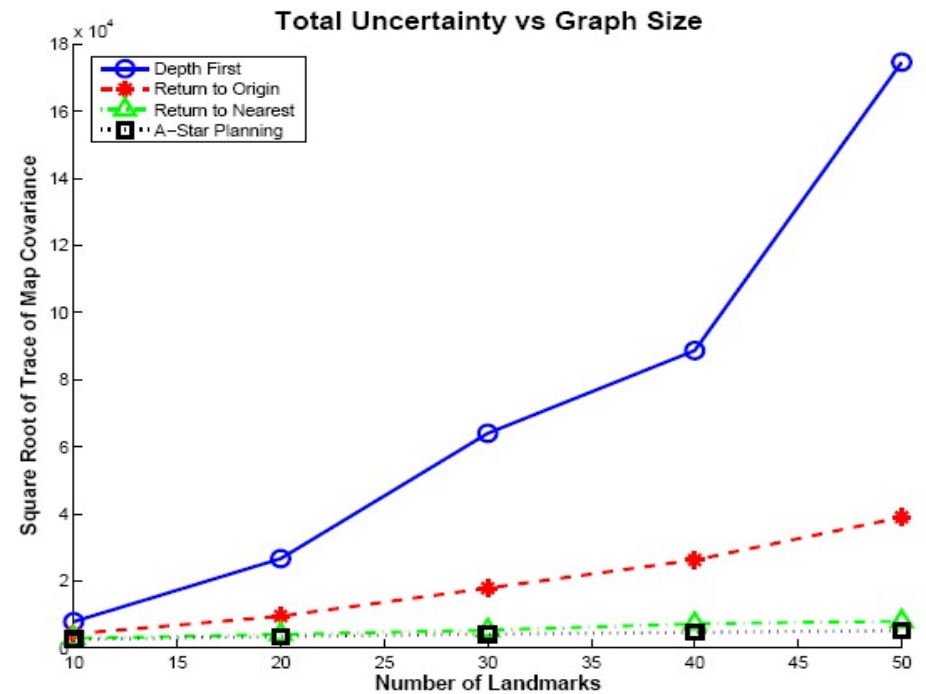
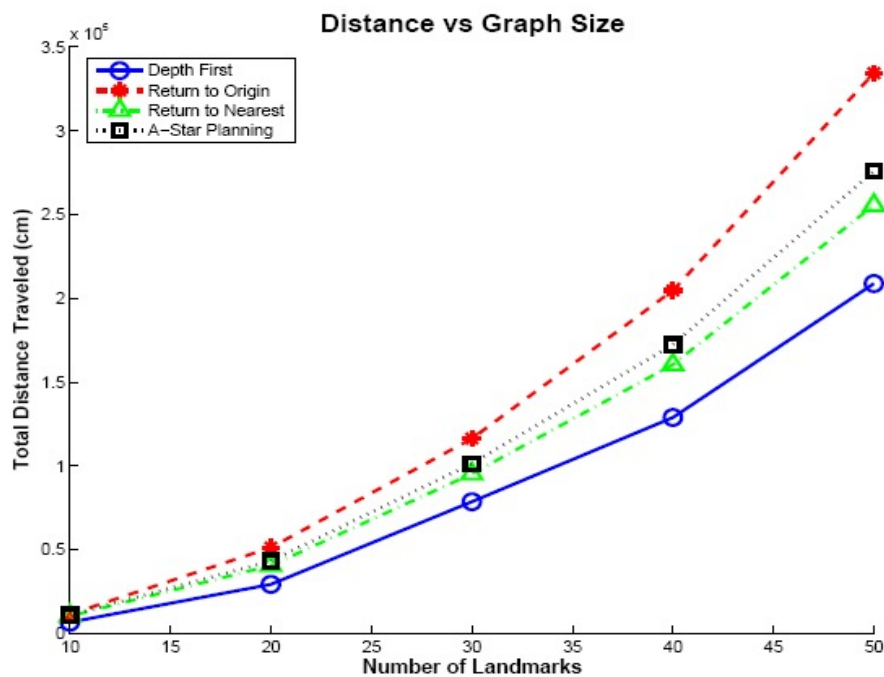

Ear-Based Exploration Algorithm

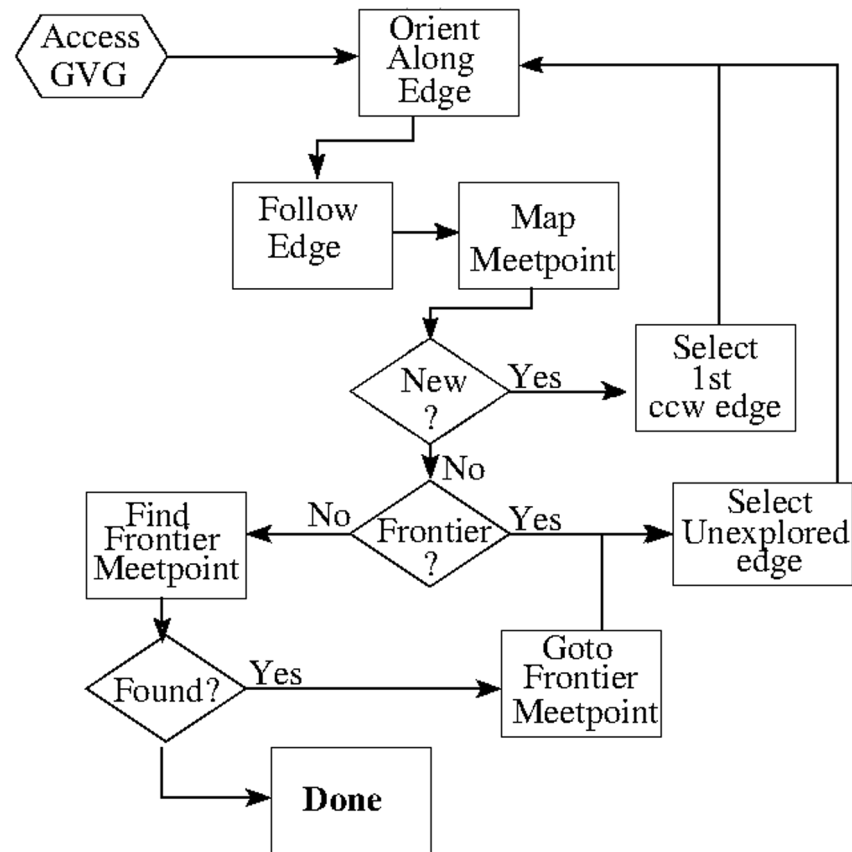

Exploration of the GVG

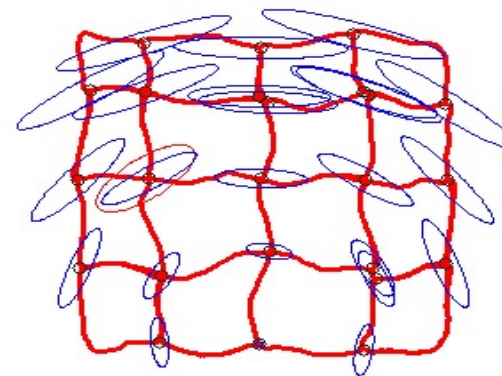
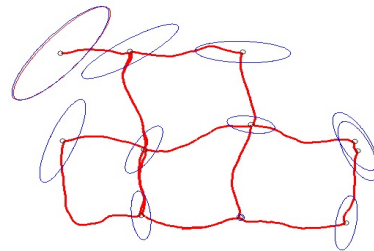
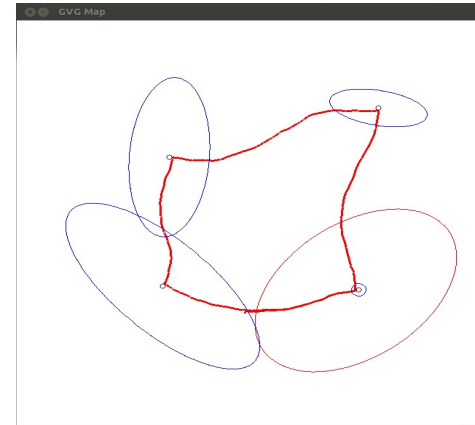
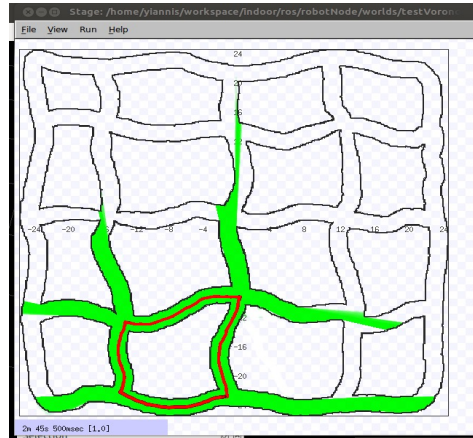

Simulation in StageRos



Ear based exploration

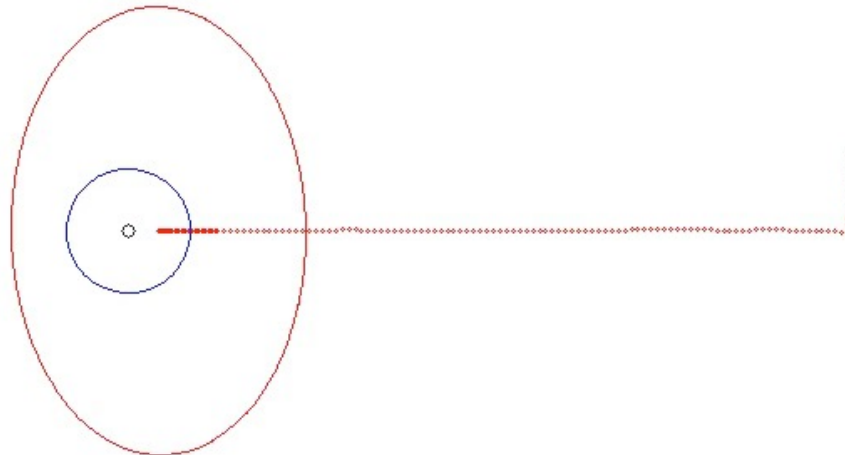

Exploration of the GVG

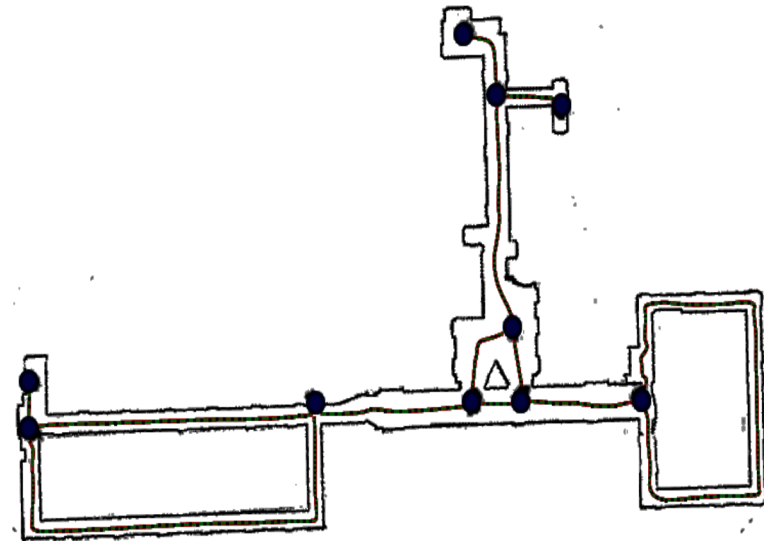
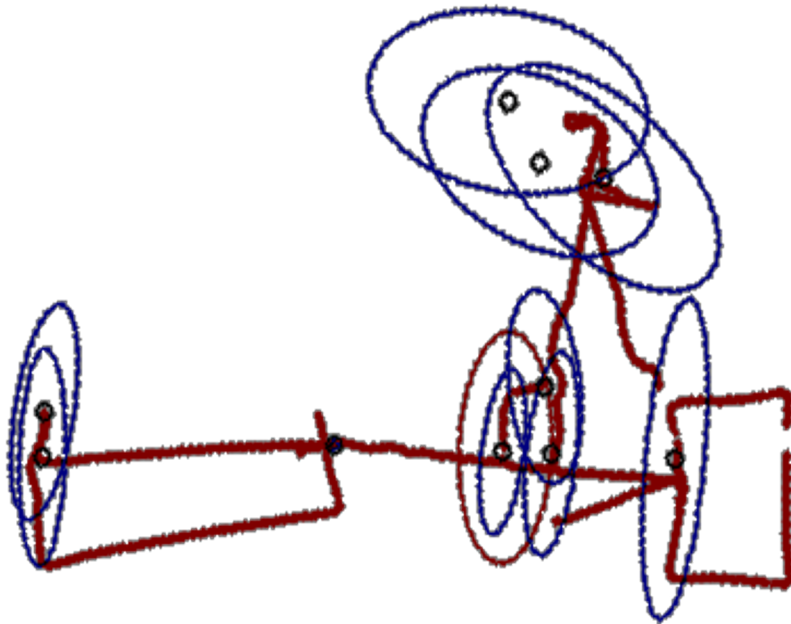

Real environment, McConnell 4th floor

Exploration of the GVG

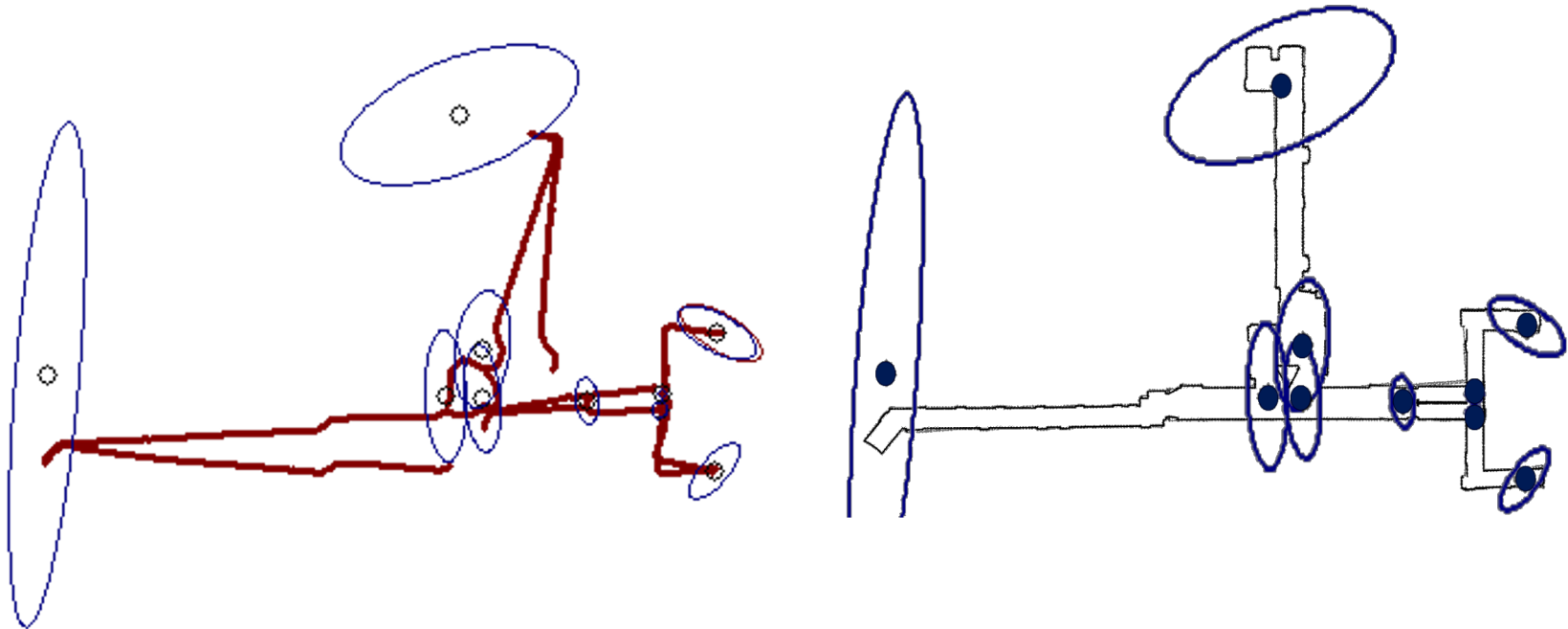

Real environment, McConnell 3rd floor

Video of the Ear-based Exploration

Ear-based Exploration on Hybrid Metric/Topological Maps

Q. Zhang, D. Whitney, F. Shkurti, and I. Rekleitis
School of Computer Science, McGill University



Exploration Key Points

- Mapping requires exploration
- Exploration strategies depend on the representation
- Topological representations are the most convenient for exploration
- Two objectives:
 - Explore new territory
 - Improve the accuracy by relocalization

